

Pure Passion



PRODUCTS

For Cleanroom Hygiene

Edition 4 | English

Why Hydroflex?

We make cleanroom cleaning **simple** and **effective!**

Hydroflex not only develops and produces cleanroom products, but much rather customer specific solutions and innovative **hygiene concepts**. All with the expertise of a specialist.

Realized with advanced technologies and materials. And with a focus on ergonomic handling.

The outcome: efficient, functional and resource saving **solutions** for cleanroom cleaning.

At Hydroflex, everything begins with competent **consultancy**.

And, if required, is completed with the training of your cleaning personnel.

This gives you the **safety** of a clean cleanroom.

Passionate about CLEAN rooms

Dear customers,

For four decades we have been focused on cleanliness in industrial environments. In 2009 Hydroflex set out to meet the high requirements for cleanliness and hygiene in the pharmaceutical industry, with the aim to rethink cleanroom cleaning. This resulted in easy-to-use and effective mopping systems for manual cleaning, which have become a benchmark in the industry. They are used in cleanrooms of all types and a wide range of high-tech industries. Today we develop and deliver premium cleanroom solutions under the brands PurMop® and PurWipe® to cleanroom operators in over 50 countries worldwide.

We hope you will find interesting solutions for your cleanroom in our current catalogue.

With the best wishes

Terry R. Becker and **Edward Becker**
Managing Directors



What we stand for

Certified quality

Hydroflex views itself as a competent problem solver for cleanroom cleaning challenges. Always focussing on the operator and a simple but safe cleaning of GMP and technical cleanrooms, our cleaning systems undergo continuous further development.

Because of the critical environment of their application, cleanroom products are subject to high quality demands. Our products are specifically developed for the use in these sensitive areas and are tested extensively to their specific requirements. This is done in our in-house test laboratories or in accordance with internationally recognized test standards by external test institutes. Our quality philosophy is lived through an ISO 9001:2015 certified quality management system, which follows basic GMP requirements.

Our partners benefit from:

- Highest quality standards
- Continuous development and patented innovations
- Batch related testing and documentation
- Certification by external institutes
- Comprehensive consultation and training

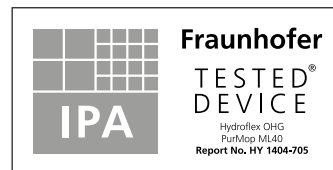

QUALITY

PASSION

DYNAMISM

PARTNERSHIP

These are our brand values

Who trusts
in us

Cleanroom hygiene in best hands

A cleanroom is a highly sensitive environment where safety and expertise are essential. This is where Hydroflex is at work. We deliver best, where the maintenance of a safe cleanroom environment is significantly influenced: in cleaning.

Instead of offering just an individual cleaning product, we consider the process of cleaning and disinfection as a whole. And as an essential part of cleanroom operation. To control critical contamination. For a safe cleanroom production.

These industries rely on Hydroflex:

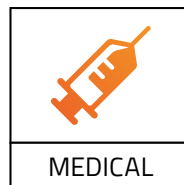
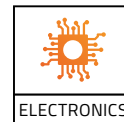

Supplying cleanrooms worldwide

Hydroflex operates internationally to provide an optimal service to our globally active customers. From the first idea to the development, testing and certification, our products are engineered in Germany and are distributed internationally through the Hydroflex Group. At our production sites in Asia, our textiles – cleanroom mops and wipes of the PurMop® and PurWipe® series – are manufactured according to recognized standards and under cleanroom environments.

Wherever you operate a cleanroom, a partner of our worldwide distribution network will be pleased to consult you and to present the optimal solution for the cleaning of your cleanroom.

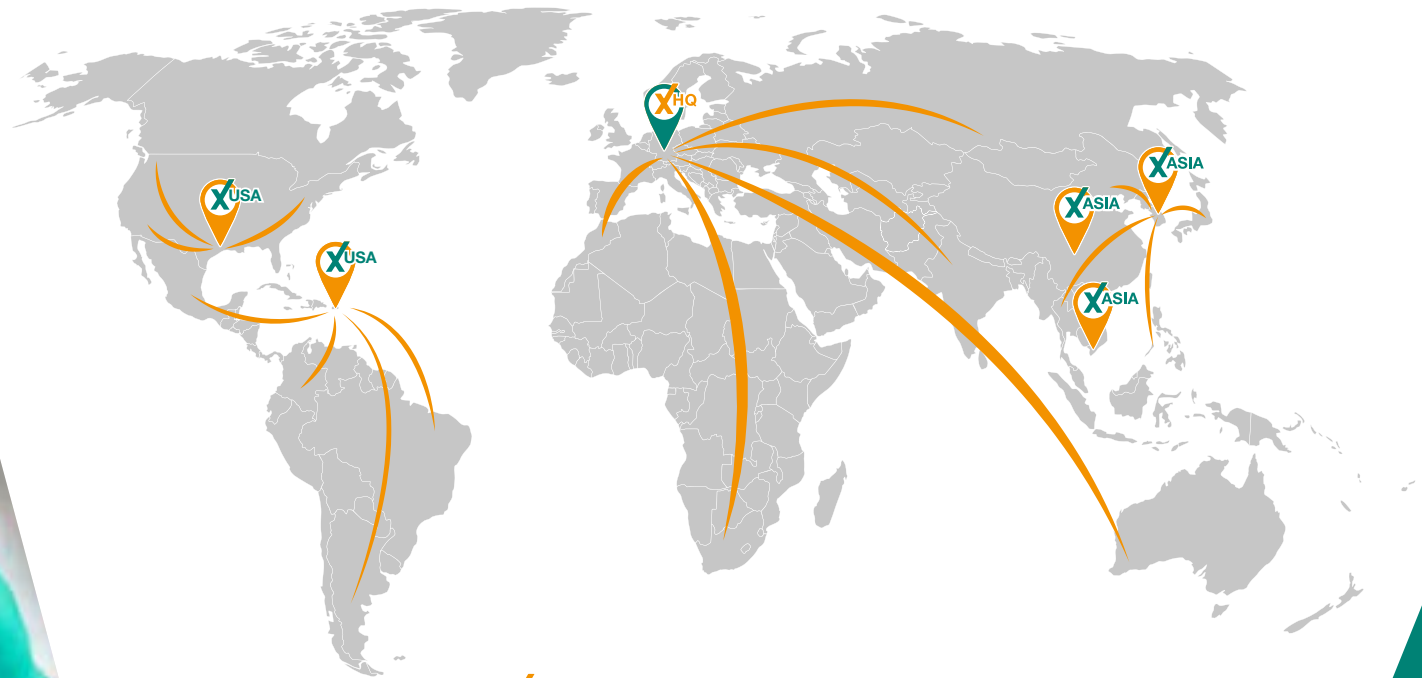

- XHQ** Hydroflex headquarters in Hesse, Germany
- XASIA** Sales subsidiary and warehouse Asia, South Korea
- XUSA** Sales subsidiary and warehouse America, USA



We add
value

From start to finish

To ensure the quality of our products, we oversee the complete supply chain of our products. Starting with the development and selection of suitable raw materials, through manufacturing processes and environments, to internal and external testing and storage under controlled environments. All processes are controlled and ISO 9001 certified for quality management.



Product development



Cleanroom production



In-house lab testing



GMP warehouse

CONTENT

PurMop® 10



Cleanroom Mops

<u>Disposable Mops</u>	<u>14</u>
<u>Reusable Mops</u>	<u>32</u>
<u>Frames & Handles</u>	<u>42</u>
<u>Cleaning Trolleys</u>	<u>58</u>

PurWipe® 86



Cleanroom Wipes

<u>Disposable Wipes</u>	<u>88</u>
<u>Reusable Wipes</u>	<u>104</u>

PurGuard™ 108



Cleanroom Goggles

<u>Disposable Goggles</u>	<u>110</u>
<u>Reusable Goggles</u>	<u>112</u>

114



Service

<u>Allround service</u>	<u>114</u>
<u>Cross references</u>	<u>118</u>

Hydroflex

PurMop®
**MOPPING
SYSTEMS**

For effective contamination control



12

PurMop® Cleanroom Mops
Certified cleanroom mops, designed for highest cleaning performance.



42

PurMop® Frames & Handles
High quality cleaning tools for ergonomic cleanroom cleaning.



58

PurMop® Cleaning Trolleys
German engineered, user friendly cleanroom trolley systems.



PurMop®

CLEANROOM MOPS

Easy handling – effective results

The mop head is the center-piece of every cleanroom mopping system. Its task is to effectively remove surface contamination as well as to evenly distribute disinfectant solution. Cleanroom mops should be easy to handle, clean and safe at every usage, while still being cost-effective. PurMop® disposable mops combine these features perfectly.

PurMop® sets the benchmark

PurMop® has become internationally synonymous with microfiber cleaning efficiency and highest quality standards in cleanroom cleaning, and is used thousands of times every day in cleanrooms around the world.

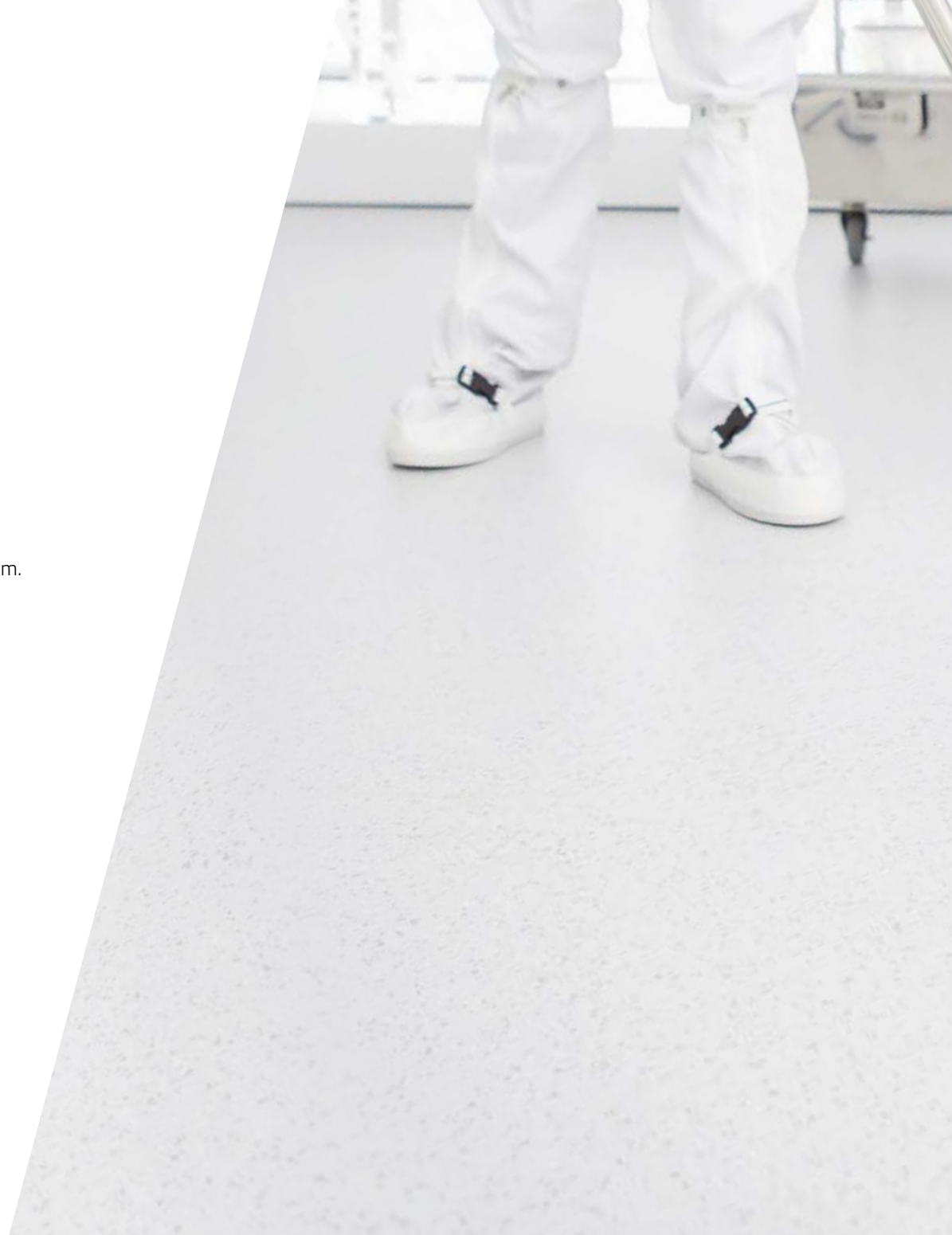



Disposable Mops

Dry E-Series	14
Presaturated V-Series	20
Isolator Cleaning ICT-Series	24
Packaging Concept	30

Reusable Mops

Cleanroom M-Series	32
Non cleanroom SaniMop™	40

A person wearing a full white protective suit, including a hood and goggles, and green gloves is using a long-handled mop on a light-colored floor. The mop has a long silver handle and a green and white head. In the background, there is a stainless steel table with a microscope and other lab equipment, and a metal cart with a white plastic bag. The scene is set in a clean, brightly lit laboratory or clinical environment.

PurMop®

E-SERIES

Disposable Mops | dry

Single-Use Cleanroom Mops

Controlling critical cleanroom contamination – one clean mop at a time

PurMop® disposable mops perfectly meet the high requirements for safety and consistent quality in cleanroom cleaning. With the PurMop® E-Series we offer a range of cleanroom mops which deliver superior cleaning performance.

- High-Tech microfiber material
- Cleanroom processed with full documentation for every batch
- Certified by the German Fraunhofer Institute
- Designed for maximum performance using minimal resources
- Sterile mops with 10^{-6} validated gamma irradiation



Performance

PurMop® Thintelligence stands for maximum absorption and surface cleaning ability with lowest material weight. This uses less resources and saves disinfectant.



Packaging

A detailed packaging concept along with cleanroom suitable packaging materials are standard for all our PurMop® cleanroom mops.

The triple packaging allows contamination-free entry into any cleanroom area.



Ergonomics

Our mopping systems enable users to clean surfaces reliably without hand contact and with optimal ergonomics.

PurMop® EC 40

Disposable Cleanroom Mop
Polyester Knit

- High-quality knit material, made from 100 % Polyester
- Structured cleaning layer for improved dirt removal
- Consistently low particle emission
- Very good gliding properties on all surfaces
- High area performance due to fluid reservoir

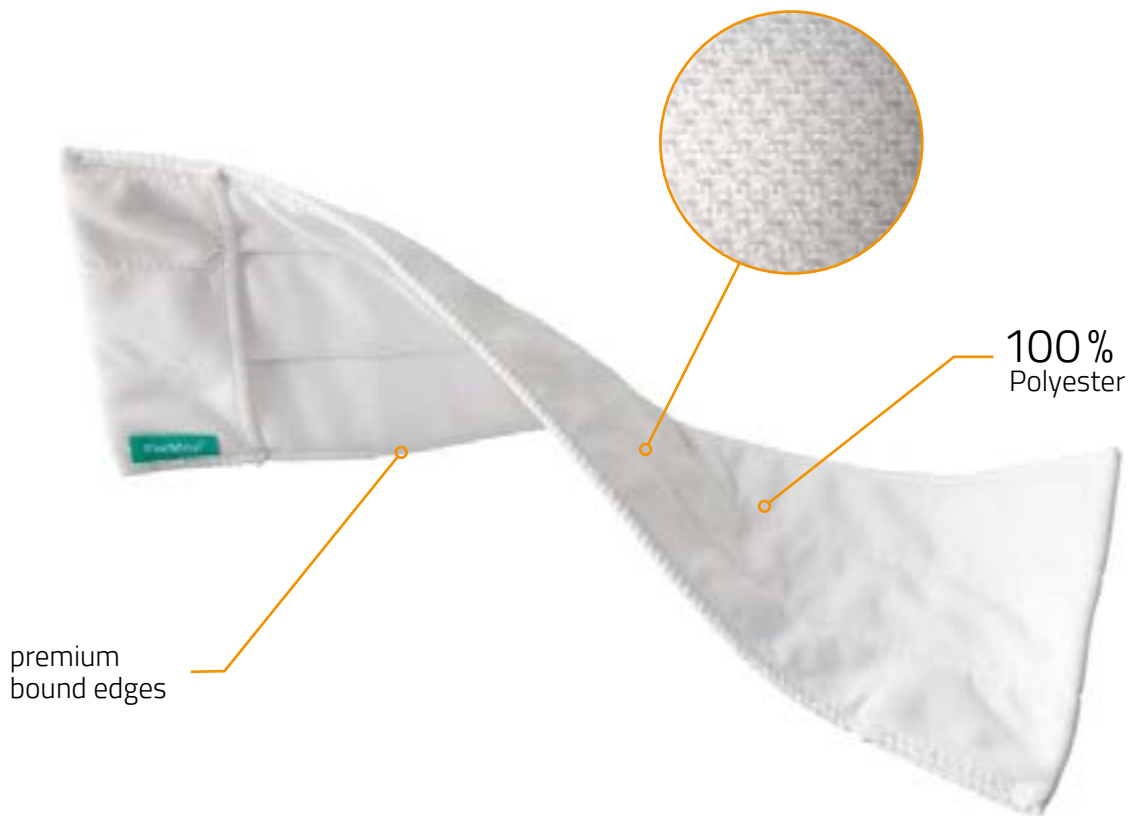

EC40

- Size: 40 cm
- Packaging: 5 pcs / double bag, 20 bags / carton [case = 100 pcs]

Item no. 2111104

ISO	3	4	5	6	7	8
GMP			A/B		C	D

EC40 PLUS

- With additional inserts
- Size: 40 cm
- Packaging: 5 pcs / double bag, 20 bags / carton [case = 100 pcs]

Item no. 2111115

ISO	3	4	5	6	7	8
GMP			A/B		C	D

EC40-S [STERILE]

- Size: 40 cm
- Packaging: 5 pcs / double bag (pack), 20 packs / carton [case = 100 pcs]

Item no. 2111105

ISO	3	4	5	6	7	8
GMP			A/B		C	D

EC40-S PLUS [STERILE]

- With additional inserts
- Size: 40 cm
- Packaging: 5 pcs / double bag (pack), 20 packs / carton [case = 100 pcs]

Item no. 2111116

ISO	3	4	5	6	7	8
GMP			A/B		C	D

Application

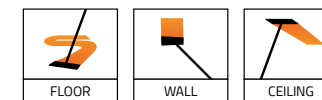

Industries



PurMop® EF 40

Disposable Cleanroom Mop
Polyester-Microfiber

- 3D cleaning material for good particle pick-up
- Exceptional cleaning performance due to high-tech microfiber
- High area performance due to special fluid reservoir
- Good gliding and handling properties on most flooring types

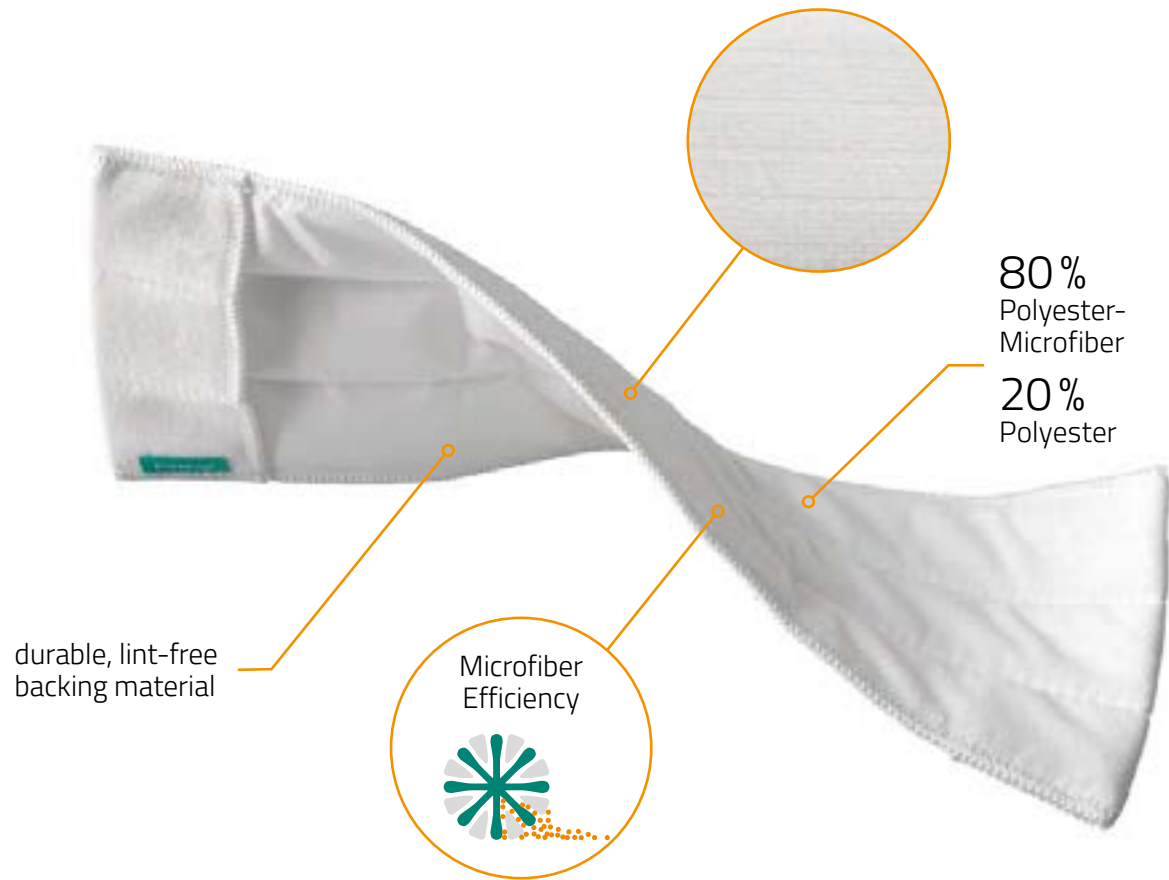

EF40

- Size: 40 cm
- Packaging:
5 pcs / double bag,
20 bags / carton
[case = 100 pcs]

Item no. 2111108

ISO	3	4	5	6	7	8
GMP			A/B		C	D

EF40-S [STERILE]

- Size: 40 cm
- Packaging:
5 pcs / double bag (pack),
20 packs / carton
[case = 100 pcs]

Item no. 2111109

ISO	3	4	5	6	7	8
GMP			A/B		C	D

Application

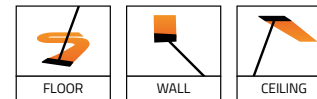

Industries



PurMop® EFB 40

Disposable Cleanroom Mop

Polyester-Microfiber +
Scrub Stripes

- 3D cleaning material for good particle pick-up
- Polyester scrub stripes for removal of residues
- Hightech microfiber for retention of particles
- Superior gliding and handling properties

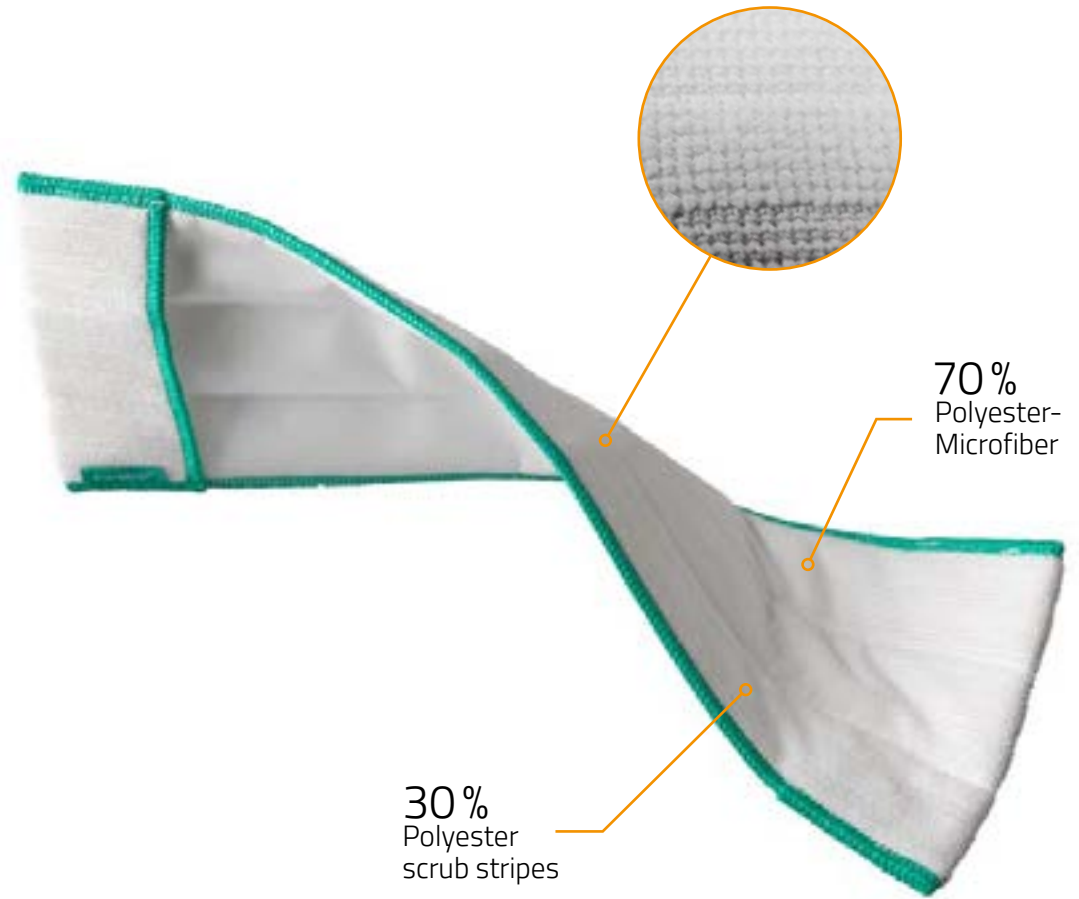

EFB40

- Size: 40 cm
- Packaging:
5 pcs / double bag,
20 bags / carton
[case = 100 pcs]

Item no. 2111117

ISO	3	4	5	6	7	8
GMP			A/B		C	D

EFB40-S [STERILE]

- Size: 40 cm
- Packaging:
5 pcs / double bag (pack),
20 packs / carton
[case = 100 pcs]

Item no. 2111118

ISO	3	4	5	6	7	8
GMP			A/B		C	D

Application



Industries



INCREASED
CLEANING ABILITY

PurMop® EX 40

Disposable Cleanroom Mop
Polyester-Microfiber

- Highest cleaning ability due to special microfiber technology
- Superior area performance through multiple fluid absorbing inserts
- Even and fine fluid distribution on the surface
- Ergonomic handling due to ideal gliding properties
- Can be washed and reused outside of cleanrooms

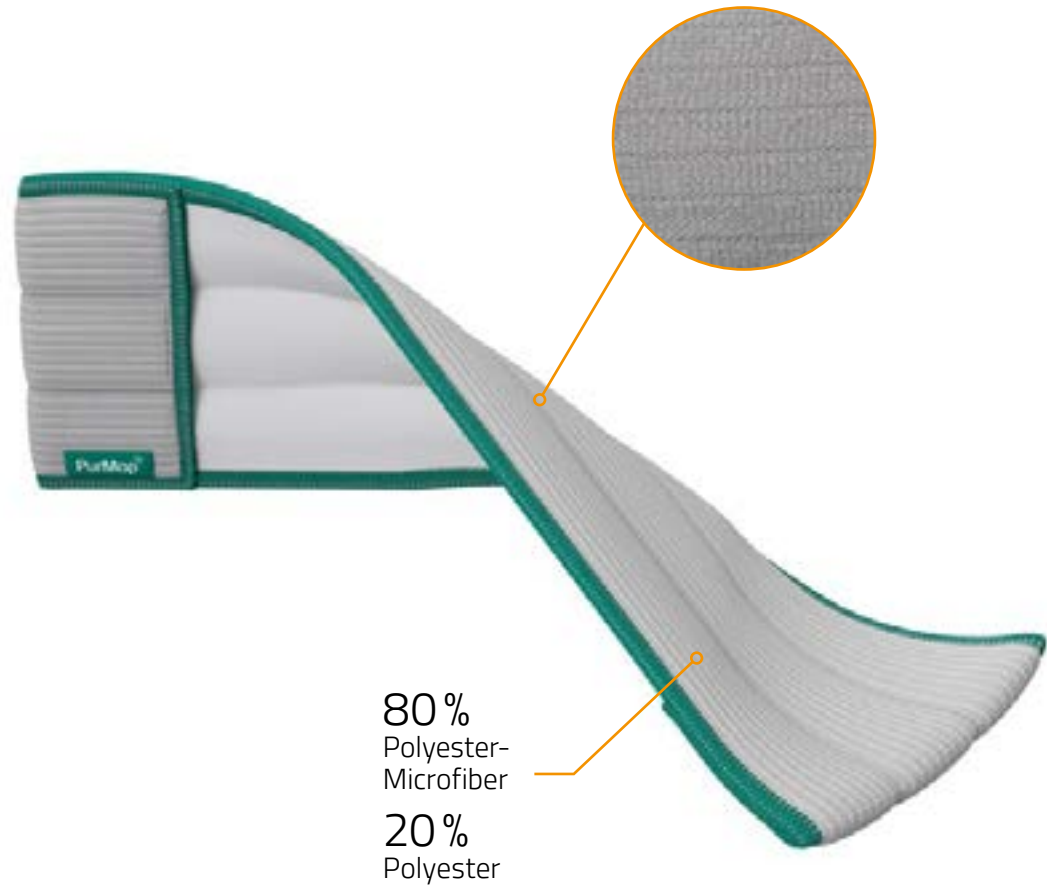

EX40

- Size: 40 cm
- Packaging:
10 pcs / double bag,
10 bags / carton
[case = 100 pcs]

Item no. 2111138

ISO	3	4	5	6	7	8
GMP			A/B		C	D

Application

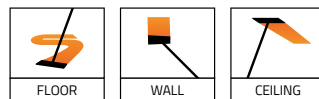

Industries



COST EFFECTIVE OPTION!
Available as part of PurMop® Xtra
reuse programm (depending on country)



PurMop®

V-SERIES

Disposable Mops | presaturated with alcohol

Presaturated Cleanroom Mops

Ready-2-Use for optimal convenience and safety

PurMop® V-Series: The fastest and most comfortable way to clean a cleanroom! With our Ready-2-Use presaturated disposable mops, we offer an innovative solution that makes cleaning much easier, especially in small cleanrooms. Packaged presaturated with IPA solution and water, there is no need for a trolley system.

- Microfiber mops with high cleaning performance
- Delivered presaturated and ready-to-use
- Enables very quick and flexible usage
- Correct fluid level in each mop
- Particularly suitable for small cleanrooms
- Can be used without additional cleaning trolley



Disinfectant

- IPA or Ethanol
- Low residues disinfectant cleaner
- 0,2 µm filtered
- With water in DI or WFI quality
- Microbiological efficacy tested



Ready-to-use

With PurMop® V-Series there is no need to prepare disinfectant solution in buckets before cleaning starts. The need to wet and wring each mop is eliminated.



Safe results

PurMop® V-Series mops are packed and filled in cleanroom class ISO 5. They are pre-soaked with the right amount of fluid. This avoids variations in fluid level during usage and ensures a safe and validatable disinfection result.

PurMop® EF 40-SV

Disposable Cleanroom Mop |
Presaturated

Polyester-Microfiber

- Presaturated with IPA 70/30, ready-to-use
- Exceptional cleaning performance due to high-tech microfiber
- High area performance due to special fluid reservoir
- Good gliding and handling properties on most flooring types
- Also suitable for glass and stainless steel surfaces

Disinfectant



special foil pouch
with easy-tear



double packaging

Optionally available presaturated with Ethanol

EF40-SV [STERILE]

- Presaturated with IPA 70% / DI water 30%
- Size: 40 cm
- Packaging: 5 pcs / double bag (pack), 10 packs / carton [case = 50 pcs]

Item no. 2111129

ISO	3	4	5	6	7	8
GMP			A/B		C	D

EF40-SV-2P [STERILE]

- Presaturated with IPA 70% / DI water 30%
- Size: 40 cm
- Packaging: 2 pcs / double bag (pack), 25 packs / carton [case = 50 pcs]

Item no. 2111130

EF40-SV II [STERILE]

- Presaturated with IPA 70% / WFI quality water 30%
- Size: 40 cm
- Packaging: 5 pcs / double bag (pack), 10 packs / carton [case = 50 pcs]

Item no. 2111149

ISO	3	4	5	6	7	8
GMP			A/B		C	D

EF40-SV-2P II [STERILE]

- Presaturated with IPA 70% / WFI quality water 30%
- Size: 40 cm
- Packaging: 2 pcs / double bag (pack), 25 packs / carton [case = 50 pcs]

Item no. 2111150

Application

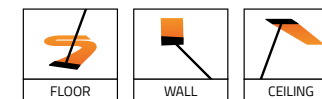

Industries



PurMop® EFB 40-SV

Disposable Cleanroom Mop |
Presaturated

Polyester-Microfiber with
Scrub Stripes

- Presaturated with IPA 70/30, ready-to-use
- 3D cleaning material for good particle pick-up
- Polyester scrub stripes for removal of residues
- Hightech microfiber for retention of particles
- Superior gliding and handling properties

Disinfectant

IPA
ISOPROPANOL

Optionally available presaturated with Ethanol

EFB40-SV [STERILE]

- Presaturated with IPA 70% / DI water 30%
- Size: 40 cm
- Packaging:
5 pcs / double bag (pack),
10 packs / carton
[case = 50 pcs]

Item no. 2111134

ISO	3	4	5	6	7	8
GMP			A/B		C	D

EFB40-SV II [STERILE]

- Presaturated with IPA 70% / WFI quality water 30%
- Size: 40 cm
- Packaging:
5 pcs / double bag (pack),
10 packs / carton
[case = 50 pcs]

Item no. 2111147

ISO	3	4	5	6	7	8
GMP			A/B		C	D

special foil pouch
with easy-tear



double packaging

Application



Industries



V-Series mops are perfect in combination with the compact cleanroom trolley PREPARE (pick up and removal of mops)

A person wearing a full white protective suit, including a hood and goggles, is using a long-handled mop. The person is wearing green gloves. The background is a clean, white environment, likely a cleanroom or isolator. The mop has a long, silver handle and a white head.

PurMop®

ICT-SERIES

Disposable Mops for Isolator Cleaning

Isolator Cleaning Tool

Minimizing risk and enhancing user comfort

PurMop® ICT is a special compact cleaning tool for isolators, workbenches and hard to access areas in GMP- and sterile cleanrooms. It comprises three parts: handle, mop frame and disposable mop pad of the EC20-Series.

- Ergonomic, lightweight tool, made from autoclavable & resistant materials
- Enables increased user safety for the disinfection of health-hazardous areas such as safety workbenches
- For easy accessibility of hard to reach areas and equipment parts
- High quality, single-use polyester mop pads



Mop Pad

The PurMop® EC20-Series mop pads are constructed from 2-ply polyester material with an embossed structure. The multilayer design ensures good fluid absorption and even distribution.



Packaging

A detailed packaging concept along with cleanroom suitable packaging materials are standard for all our PurMop® cleanroom mops. The triple packaging allows contamination-free entry into any cleanroom area.



Usage

The ICT cleaning tool is available with fixed or extendable short handles in lightweight aluminium or durable stainless steel.

PurMop® EC 20-S

Disposable Cleanroom Mop
for ICT

Polyester Knit

- Durable 2-ply polyester knit material with an embossed structure for high cleaning efficiency
- Suitable for glass and stainless steel surfaces
- Low particle emission, for use in GMP A/B environments

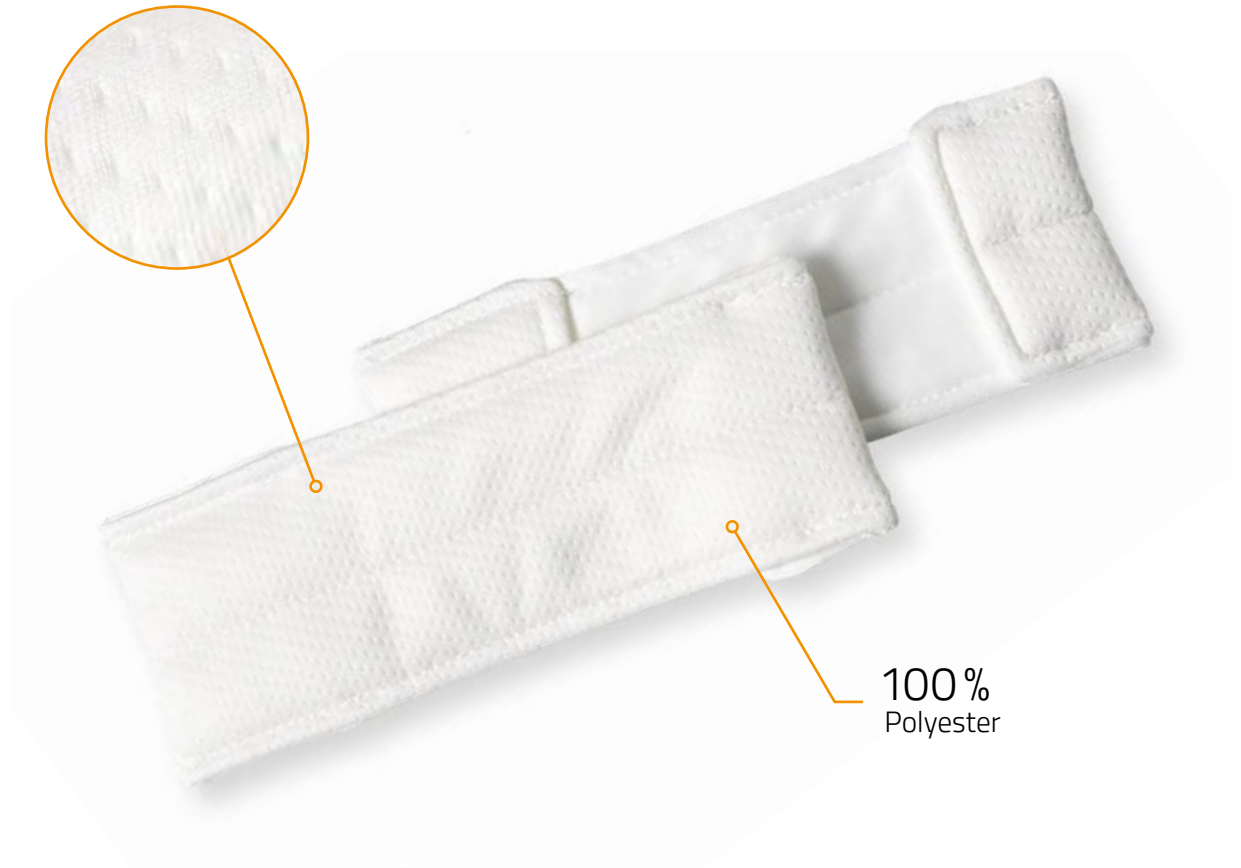

100%
Polyester

EC20-S [STERILE]

- Size: 20 cm
- Packaging:
2 pcs / double bag (pack),
50 packs / carton
[case = 100 pcs]

Item no. 2111111

ISO	3	4	5	6	7	8
GMP			A/B		C	D

Application



Industries



PurMop® EC20 and EF20 are part of the ICT cleaning tool set, providing a safer alternative to a traditional wipe. ICT tool facilitates easy access of small, hard to reach areas.

PurMop®

EF 20-S

Disposable Cleanroom Mop
for ICT

Polyester-Microfiber

- High cleaning ability, ideal for removal of disinfectant residues
- High-performance microfiber material
- Allows full removal of particulate and filmic contamination from critical surfaces



80%
Polyester-
Microfiber
20%
Polyester

Microfiber
Efficiency



EF20-S [STERILE]

- Size: 20 cm
- Packaging:
2 pcs / double bag (pack),
50 packs / carton
[case = 100 pcs]

Item no. 2111155

ISO	3	4	5	6	7	8
GMP			A/B		C	D

Application



Industries



HIGHTECH
MICROFIBER

one-hundredth of a human hair

PurMop® EC 20-SV

Disposable Cleanroom Mop
for ICT | Presaturated

Polyester-Knit

- Presaturated with IPA 70/30, ready-to-use
- High-tech polyester knit with an embossed structure for high cleaning efficiency
- Suitable for glass and stainless steel surfaces
- Low particle emission

Disinfectant



special foil pouch
with easy-tear



double packaging

EC20-SV [STERILE]

- Presaturated with IPA 70% / DI water 30%
- Size: 20 cm
- Packaging:
2 pcs / double bag (pack),
20 packs / carton
[case = 40 pcs]

Item no. 2111132

ISO	3	4	5	6	7	8
GMP			A/B		C	D

EC20-SV II [STERILE]

- Presaturated with IPA 70% / WFI quality water 30%
- Size: 20 cm
- Packaging:
2 pcs / double bag (pack),
20 packs / carton
[case = 40 pcs]

Item no. 2111148

ISO	3	4	5	6	7	8
GMP			A/B		C	D

Application



Industries





Cleanroom Mops

Disposable Mops

ICT-Series

PurMop®

PACKAGING CONCEPT

A thought-out packaging concept along with cleanroom suitable packaging materials are standard for all our PurMop® cleanroom mops. The triple packaging allows contamination-free entry into any cleanroom area, while the batch-specific labelling on the inner packaging level provides maximum safety and traceability.

Outer packaging: [carton]

Printed carton
Label with all relevant details (batch number, expiry date, product details)

1 Outer packaging: [carton liner]

PE carton liner

2 Secondary packaging: [pack]

Sealed HDPE bag
With easy-tear function for easy opening

3 Primary packaging: [bag]

Sealed cleanroom HDPE bag
With easy-tear function for easy opening
Label with all relevant details (batch number, expiry date, product details)

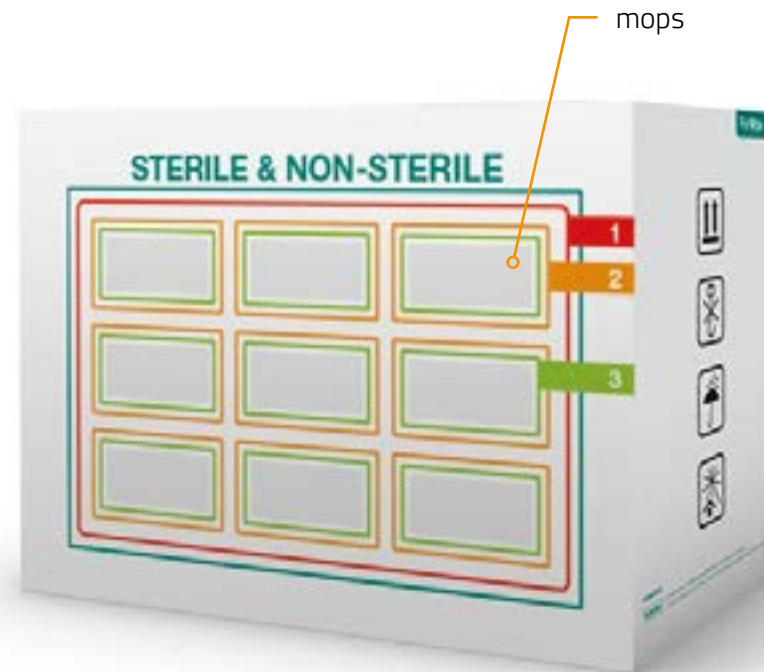



Sterilization

All PurMop® cleanroom mops are also available in sterile version, which is necessary for the utilization in sterile cleanrooms. A sterility assurance level (SAL) of 10^{-6} is achieved by gamma irradiation. The sterilization process is fully validated according to DIN EN ISO 11137 and extensively documented. A sterilization certificate is issued for each batch of sterile mops.

STERILE R



PurMop®

M-SERIES

Reusable Cleanroom Mops

Reusable Cleanroom Mops

For multiple use in a cleanroom

A range of high quality polyester and microfiber mops for decontamination and reuse in cleanrooms.

- Variety of models to suit every cleaning / disinfection application
- Extremely durable, washable and autoclavable
- Multilayer design with fluid reservoir for enhanced surface capacity
- Certified by the German Fraunhofer Institute



Quality

- Highest quality polyester knit materials
- Closed looped pile for low fiber shedding
- Resistant against a wide range of cleaning chemicals and disinfectants



Cleaning efficiency

- Looped pile allows pickup of dirt, hairs and particles from surfaces
- Brush material removes hard residues
- Microfiber enables even distribution of disinfectant



Economical

- Cost efficiency through multiple usages
- High material volume enables cleaning of heavier soiled surfaces
- Designed for 50 usage, wash and autoclave cycles in cleanrooms

PurMop®

P40

Reusable Cleanroom Mop

Polyester-Microfiber

- Knitted polyester loops (medium length)
- High fluid absorption thanks to special inserts
- Resistant to chemicals, washable and autoclavable
- Good gliding properties and easy handling
- Suitable for routine disinfection of cleanroom surfaces

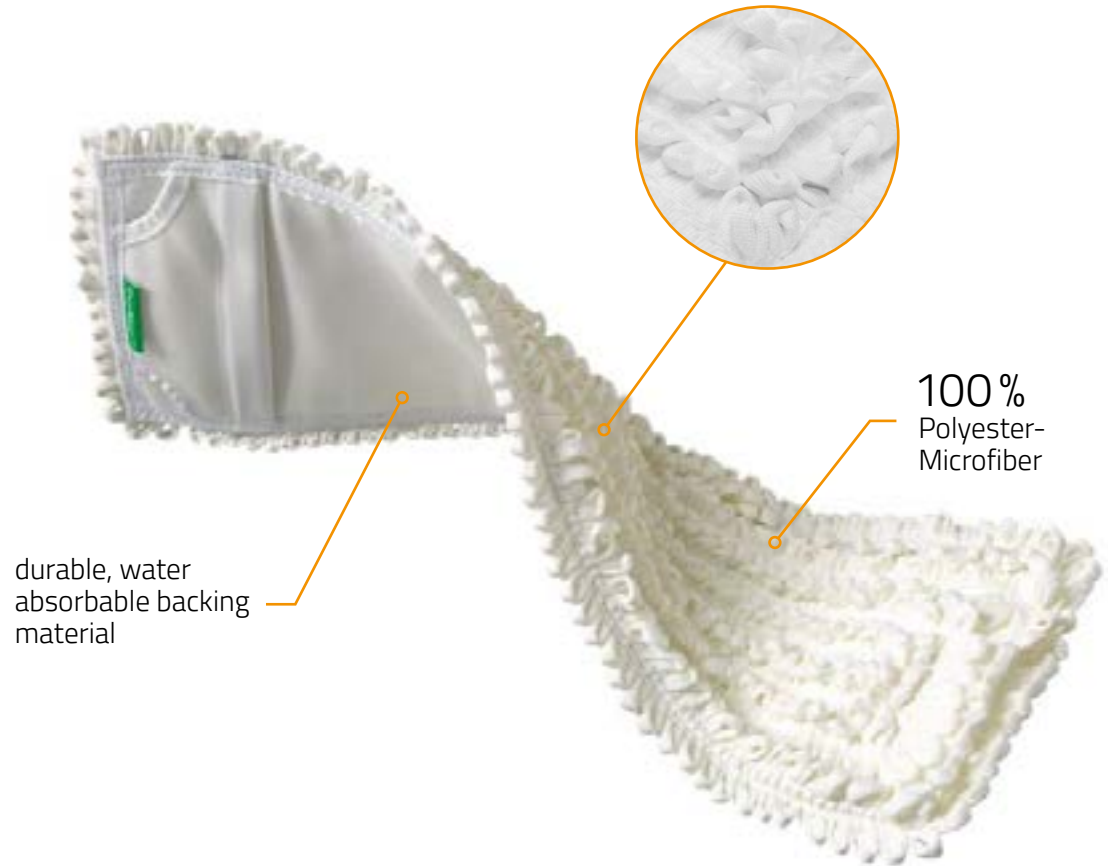

P40

- Non-sterile, autoclavable
- Size: 40 cm
- Packaging: 10 pcs / bag, 5 bags / carton [case = 50 pcs]

Item no. 2111005

ISO	3	4	5	6	7	8
GMP			A/B		C	D

Application

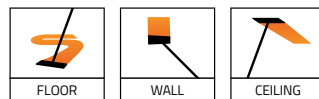

Industries



Options

- Color printing on the mops backing or pockets for identification
- Attachment of barcode or RFID chip for electronic recording / wash cycle control

PurMop®

Z40

Reusable Cleanroom Mop

Polyester-Microfiber

- Special polyester loops (short)
- High cleaning performance, even fluid distribution
- Increased area performance due to special inserts
- Good gliding properties and easy handling
- Restistant to chemicals, washable and autoclavable

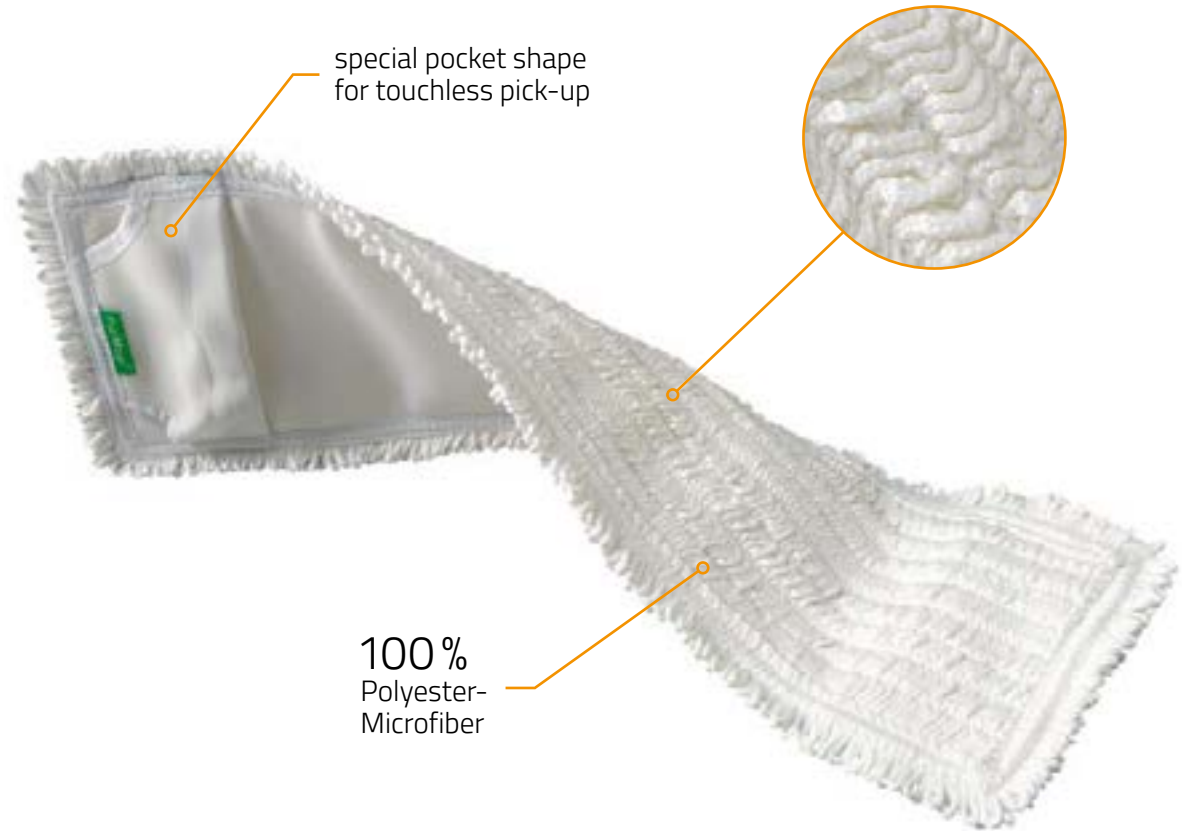

special pocket shape for touchless pick-up

100% Polyester-Microfiber



Z40

- Non-sterile, autoclavable
- Size: 40 cm
- Packaging: 10 pcs / bag, 5 bags / carton [case = 50 pcs]

Item no. 2111006

ISO	3	4	5	6	7	8
GMP			A/B		C	D

Application

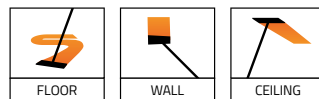

Industries



Options

- Color printing on the mops backing or pockets for identification
- Attachment of barcode or RFID chip for electronic recording / wash cycle control

PurMop® ML 40

Reusable Cleanroom Mop
Polyester-Microfiber

- TwistLoop polyester microfiber yarn
- Large absorption capacity for higher surface coverage
- High material volume for good pick-up ability
- Folded edges for optimal cleaning of corners
- Easy and touchless handling with PurMop® equipment

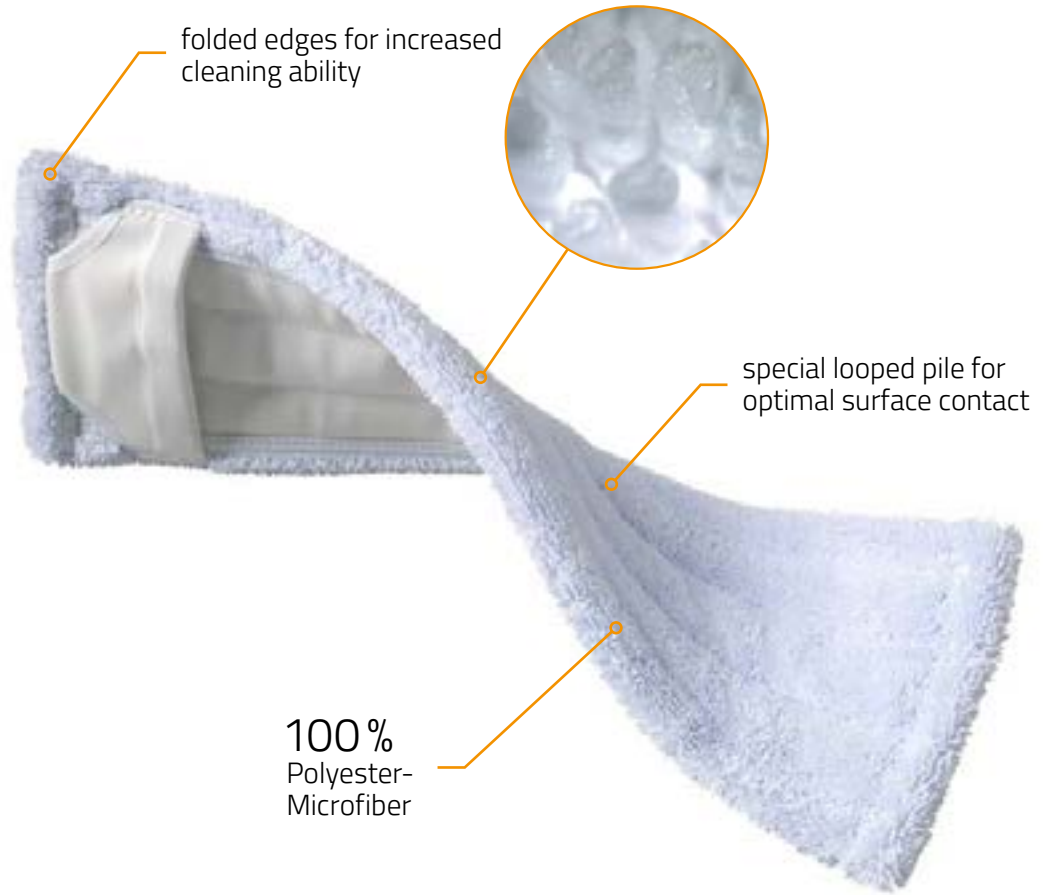

ML40

- Non-sterile, autoclavable
- Size: 40 cm
- Packaging:
10 pcs / bag,
5 bags / carton
[case = 50 pcs]

Item no. 2112008

ISO	3	4	5	6	7	8
GMP			A/B		C	D

Application

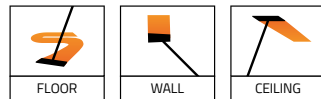

Industries



Options

- Color printing (coding) on the backing or pockets
- Attachment of barcode or RFID chip for electronic recording / wash cycle control

PurMop® MLB 40

Reusable Cleanroom Mop

Polyester / Polyamide-
Microfiber + Brush Stripes

- TwistLoop microfiber yarn with brush stripes
- Highest cleaning performance, high density cleaning pile
- Allows effective removal of residues
- Folded edges for optimal cleaning of corners
- Easy and touchless handling with PurMop® equipment

**EXCELLENT
DIRT REMOVAL**
due to scrubbing effect

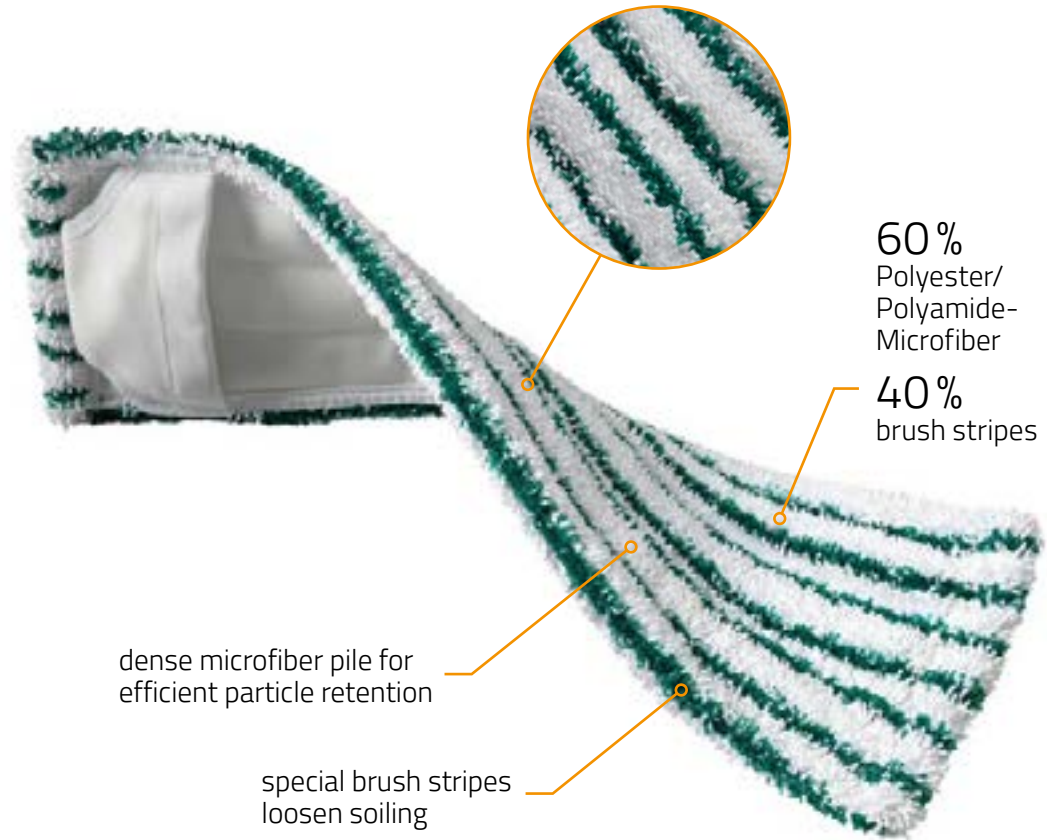

MLB40

- Non-sterile, autoclavable
- Size: 40 cm
- Packaging:
10 pcs / bag,
5 bags / carton
[case = 50 pcs]

Item no. 2112009

ISO	3	4	5	6	7	8
GMP			A/B		C	D

Application



Industries



Options

- Color printing (coding) on the backing or pockets
- Attachment of barcode or RFID chip for electronic recording / wash cycle control

PurMop® MX 40

Reusable Cleanroom Mop
Polyester-Microfiber

- Polyester-microfiber yarn
- High absorbency for higher coverage on all floors
- High material volume for great cleaning performance
- Folded edges for optimal cleaning of corners
- Extremely durable and abrasion resistant

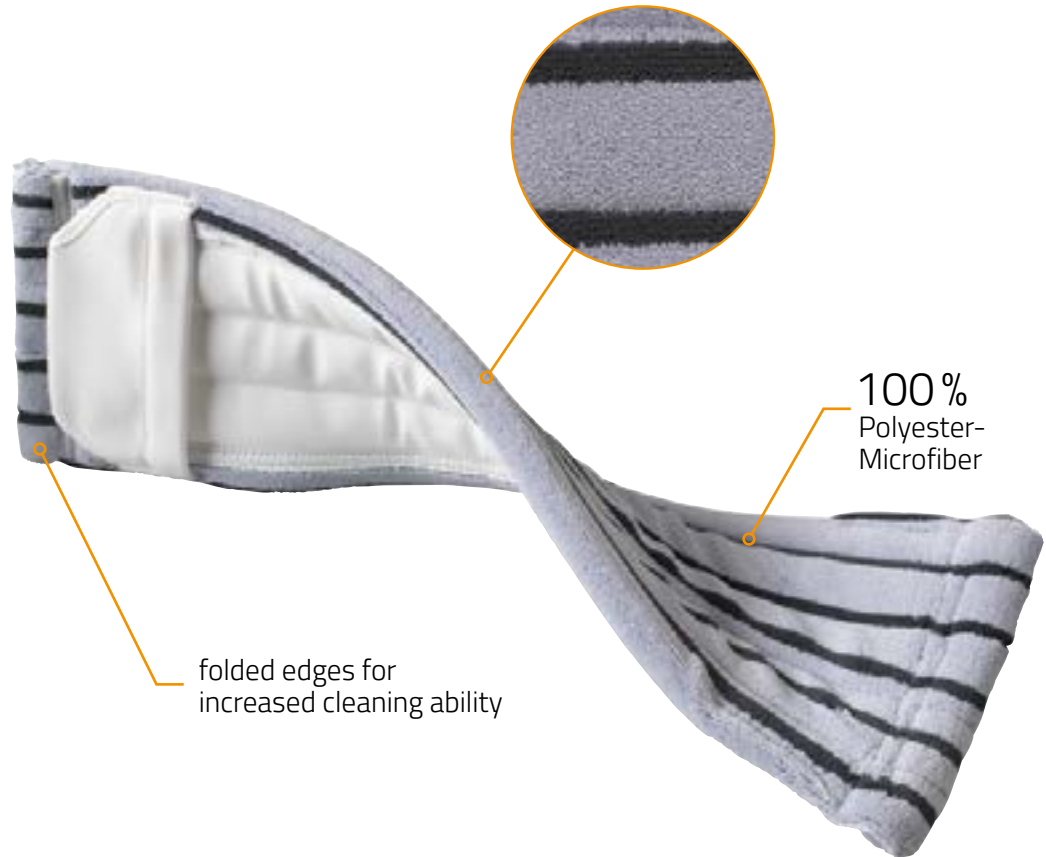

NEW
PRODUCT

MX40

- Size: 40 cm
- Packaging:
10 pcs / double bag,
5 bags / carton
[case = 50 pcs]

Item no. 2112020

ISO	3	4	5	6	7	8
GMP			A/B		C	D

Application

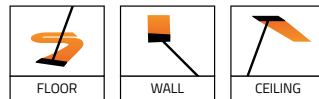

Industries



Options

- Color printing (coding) on the backing or pockets
- Attachment of barcode or RFID chip for electronic recording / wash cycle control

PurMop®

R 32/42

Reusable Cleanroom
Round Mop

Polyester-Microfiber

- Round mop with knitted polyester loops (medium length)
- Allows controlled overhead cleaning or hard to reach areas
- Resistant to chemicals, washable and autoclavable

Suitable T-Frame see page 46

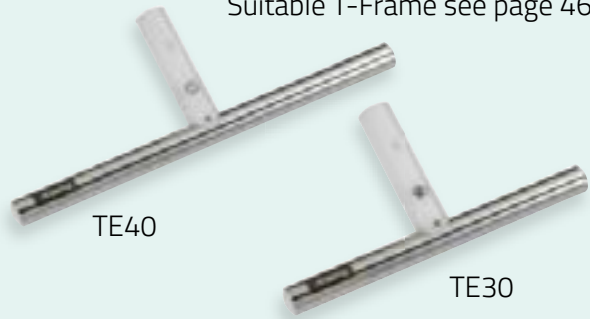

TE40

TE30

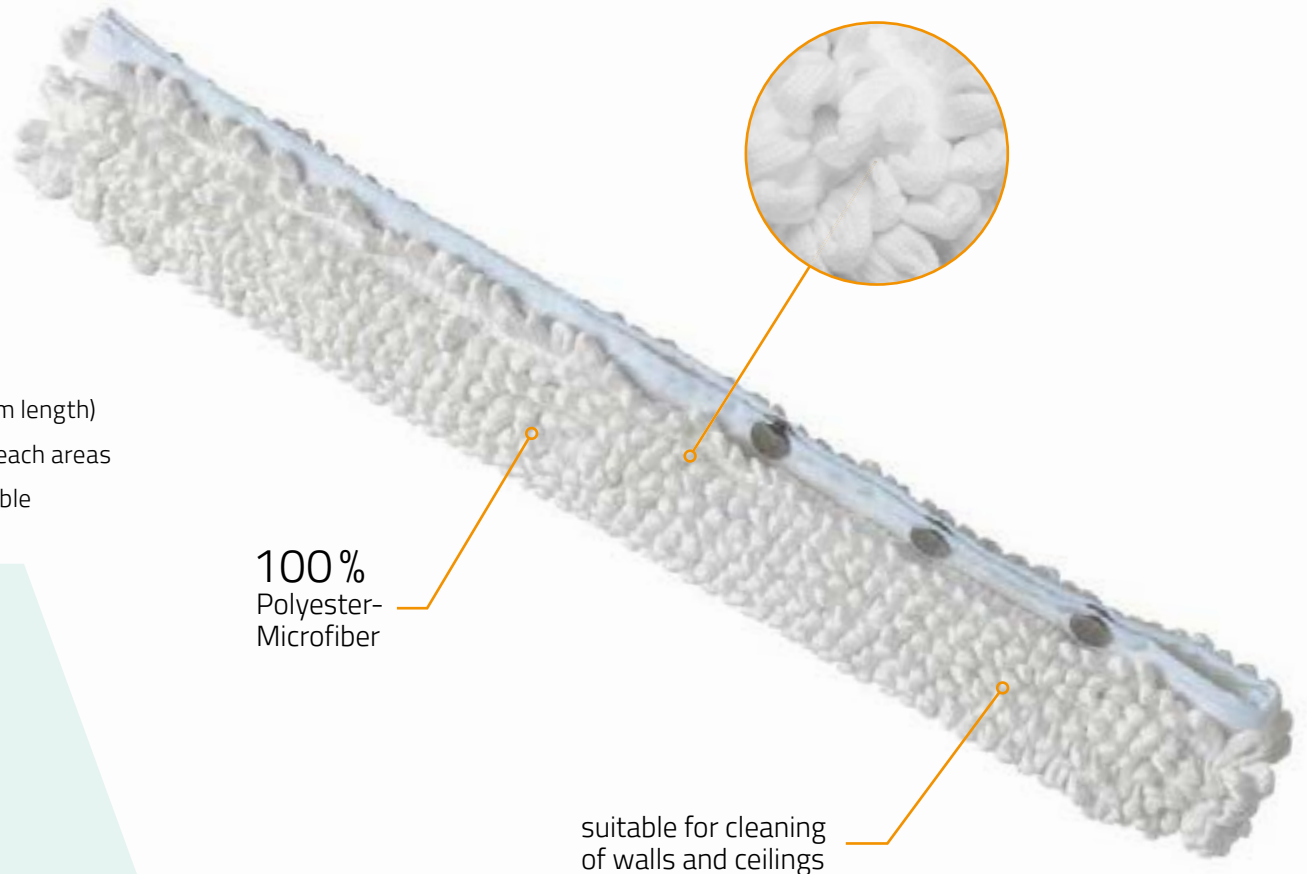

100%
Polyester-
Microfiber

suitable for cleaning
of walls and ceilings

R32

- Non-sterile, autoclavable
- Size: 30 cm
- Packaging:
10 pcs / bag,
5 bags / carton
[case = 50 pcs]

Item no. 2111007

ISO	3	4	5	6	7	8
GMP			A/B		C	D

R42

- Non-sterile, autoclavable
- Size: 40 cm
- Packaging:
10 pcs / bag,
5 bags / carton
[case = 50 pcs]

Item no. 2111008

ISO	3	4	5	6	7	8
GMP			A/B		C	D

Application

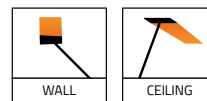

Industries



EFFECTIVE CLEANING
of surfaces in non-cleanroom
environments

SaniMop®

HYGIENE

Reusable Mop

SaniMop® B-7

Reusable Hygiene Mop

Polyester / Polyamide-
Microfiber

- Looped polyester / polyamide microfiber pile
- High fluid absorption and microfiber cleaning ability
- Folded edges for optimal corner cleaning
- With color coding system (4 zones)

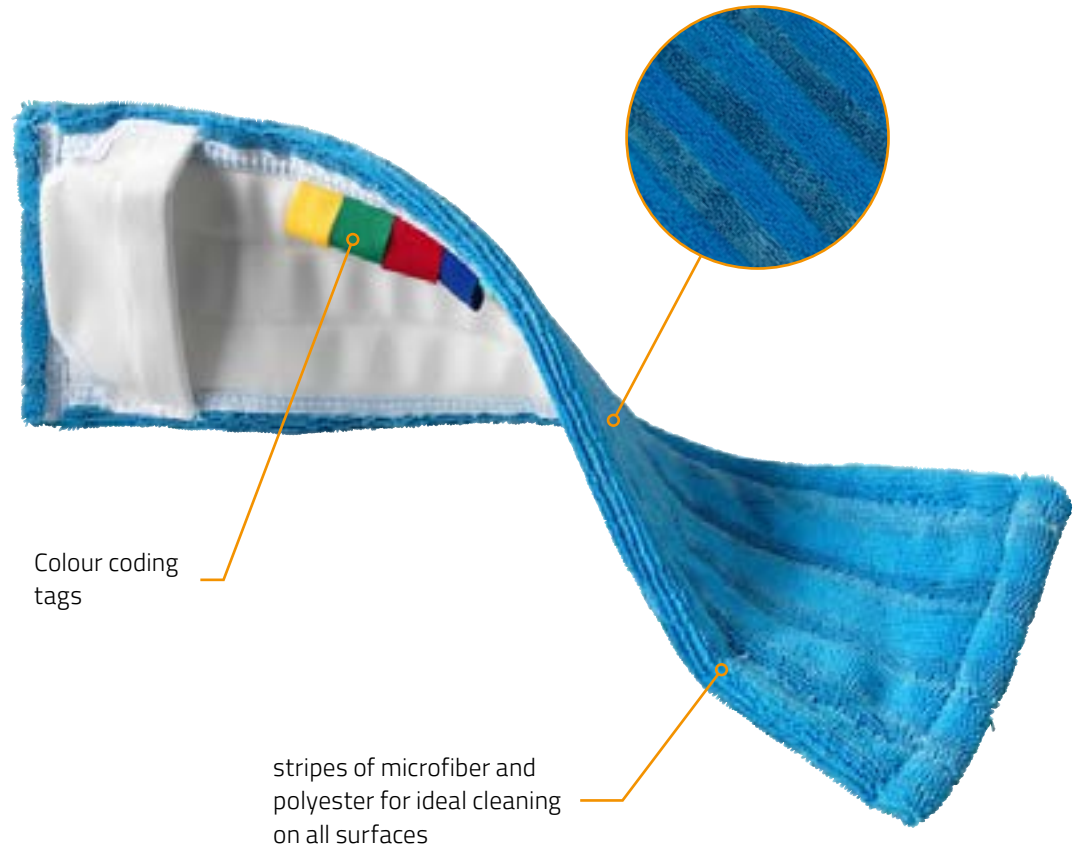

B-7

- Non-sterile, washable
- Size: 40 cm
- Also available in 50 cm
- Packaging:
10 pcs / bag,
5 bags / carton
[case = 50 pcs]

Item no. 2113001

Application

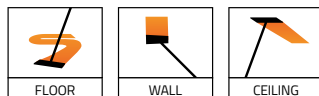

SaniMop® offers high-quality and durable reusable microfiber mops for cleaning of hygienically sensitive areas that are not classified as cleanrooms.



PurMop®

FRAMES & HANDLES

Stainless Steel | Aluminium | Plastic

Cleaning tools for a shining performance

Whether stainless steel, aluminium or plastic - PurMop® offers a wide range of high quality cleaning equipment for every cleanroom cleaning task.

Smooth, polished stainless steel surfaces ensure easy cleanability and provide long-term resistance against steam sterilization and chemicals. PurMop® plastic and aluminium tools are characterized by their light weight and excellent user friendliness. Designed for touchfree handling, with modular and screwless connections, PurMop® equipment ensures optimal ergonomics in cleanroom cleaning.





Stainless Steel

Frames	46
Handles	47

Aluminium

Handles	49
---------	----

Plastic

Frames	52
Handles	53

ICT Isolator Cleaning Tools

ICT-Sets	56
Frames & Handles	57

Good to know

During mopping, make sure to wipe only in one direction. The arrow on our frames helps you to keep the same wiping direction

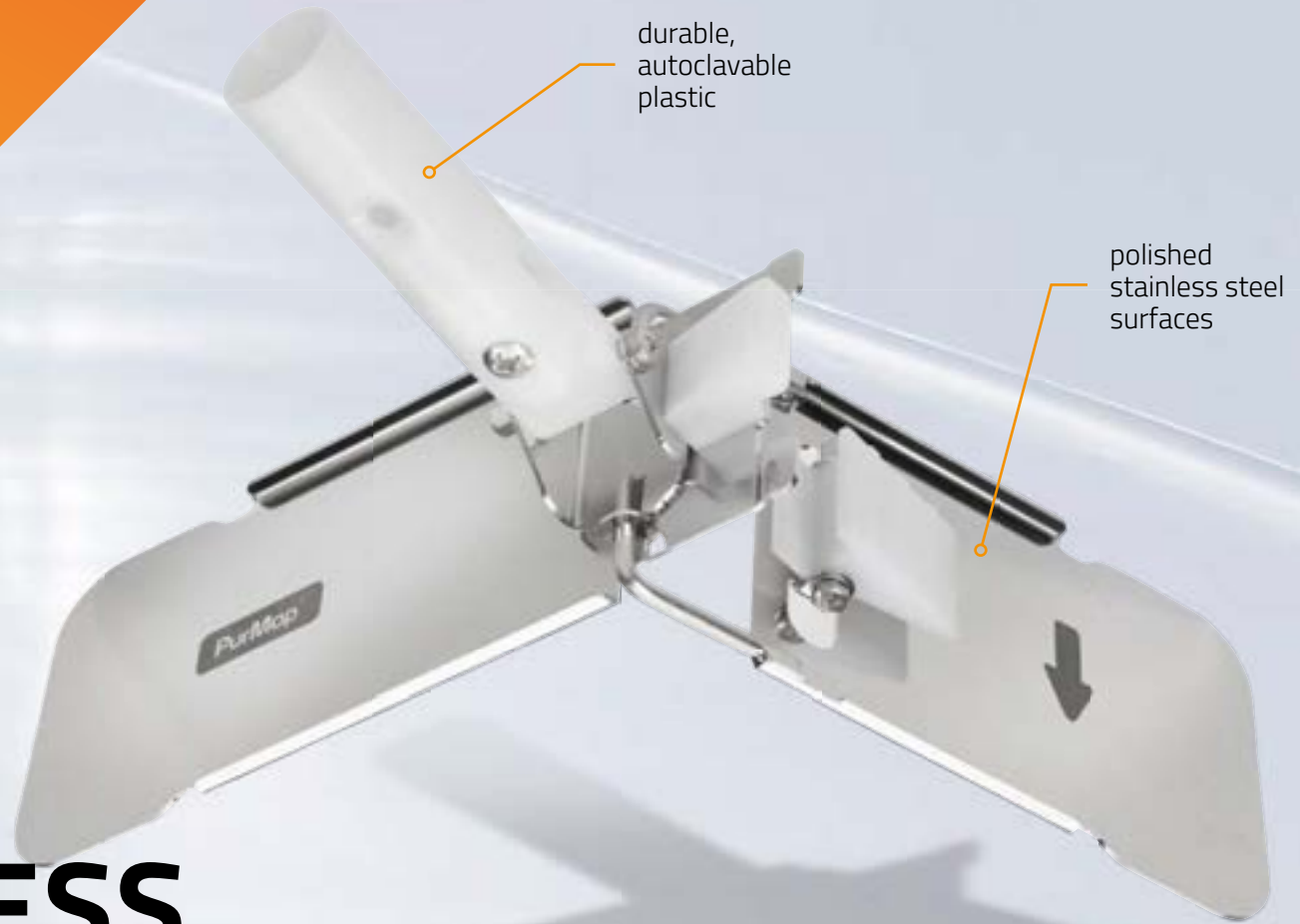

PurMop® STAINLESS STEEL

Frames & Handles

Perfectly matched – for pure performance

Manual cleaning is a craft and requires professional tools to be implemented optimally. Ergonomics and the selection of the appropriate cleaning equipment play a major role in the effectiveness and motivation of cleaning staff.

PurMop® offers a large range of cleaning equipment and accessories, developed to meet cleanroom requirements.

Touchfree handling

PurMop® mop frames are designed for mop heads to be picked up, wrung or dosed and discarded without hand contact. Thanks to the pocket design and innovative functionality of the trolleys, PurMop® guarantees safe and hygienic cleaning processes, eliminates the risk of cross-contamination and improves ergonomics.



Quick-change system

The PurMop® quick-change system allows a simple and tool-free connection between frame and handle. This saves time and enables all frames and handles to be connected with each other.

PurMop®

MOP FRAMES

Stainless Steel

Touchfree mop discarding in combination with PurMop® trolleys

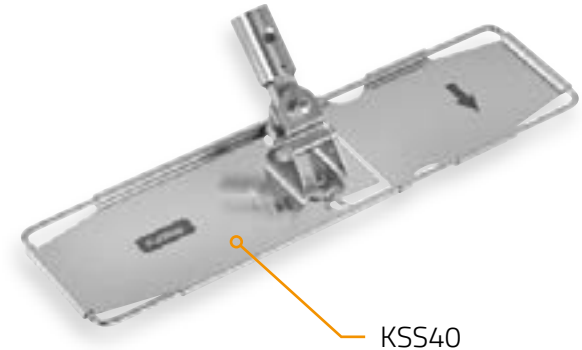
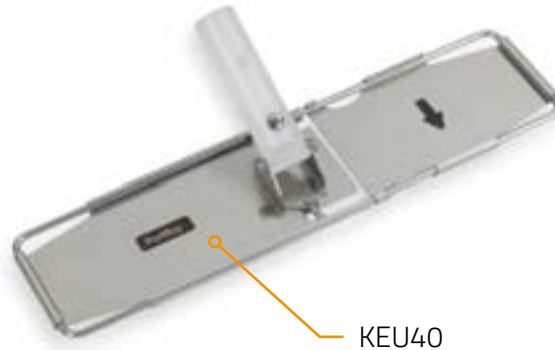
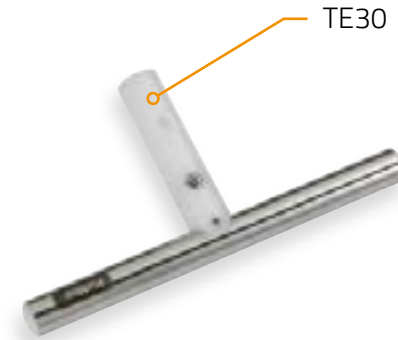
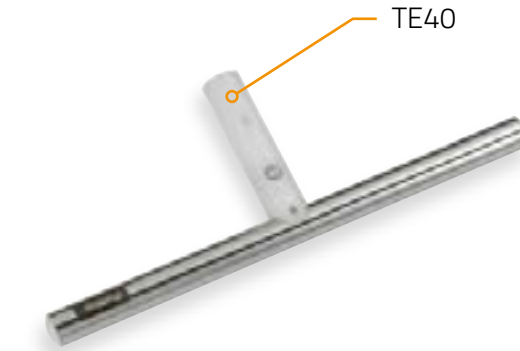
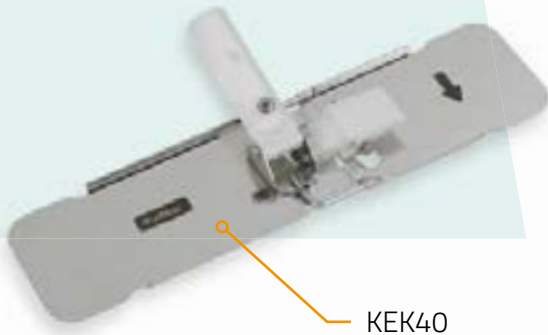

KEK40 FOLDABLE MOP FRAME

- Autoclavable, suitable for sterile cleanrooms
- Quick-change system
- Can be fixed for ceiling or wall cleaning
- Compatible with: PurMop® 40 cm mops

Item no. 2151008

ISO	3	4	5	6	7	8
GMP			A/B		C	D

KEU40 FOLDABLE MOP FRAME

- Autoclavable, suitable for sterile cleanrooms
- Quick-change system
- Compatible with: PurMop® 40 cm mops

Item no. 2151003

ISO	3	4	5	6	7	8
GMP			A/B		C	D

KSS40 FOLDABLE MOP FRAME

- Autoclavable, suitable for sterile cleanrooms
- Quick-change system
- Full stainless steel design
- Compatible with: PurMop® 40 cm mops

Item no. 2151010

ISO	3	4	5	6	7	8
GMP			A/B		C	D

TE30 & TE40 ROUND MOP FRAME | T-SHAPE

- Autoclavable, suitable for sterile cleanrooms
- Quick-change system

TE30

- Compatible with: PurMop® R32 mop

Item no. 2161001

ISO	3	4	5	6	7	8
GMP			A/B		C	D

TE40

- Compatible with: PurMop® R42 mop

Item no. 2161002

PurMop®

MOP HANDLES

Stainless Steel



FULLY AUTOCLAVABLE

SEP140 FIXED HANDLE

- Autoclavable, suitable for sterile cleanrooms
- Handle grip for ergonomic cleaning
- Quick-change system
- Length: 142 cm (fixed)

Item no. 2131003

ISO	3	4	5	6	7	8
GMP			A/B		C	D

SET2070 TELESCOPIC HANDLE | MEDIUM LENGTH

- Autoclavable, suitable for sterile cleanrooms
- Handle grip for ergonomic cleaning
- Quick-change system
- Length: 77 cm - 145 cm (adjustable)

Item no. 2131006

ISO	3	4	5	6	7	8
GMP			A/B		C	D

SET2100 TELESCOPIC HANDLE | LONG

- Autoclavable, suitable for sterile cleanrooms
- Handle grip for ergonomic cleaning
- Quick-change system
- Length: 107 cm - 205 cm (adjustable)

Item no. 2131005

ISO	3	4	5	6	7	8
GMP			A/B		C	D



Tip

The adapter enables the simple connection between stainless steel handles and plastic mop frames.

Item no. 2135032

Reaching new heights

Thanks to their light weight and long length, the handles of the aluminium series enable ergonomic cleaning of higher ceilings.

PurMop®

ALUMINIUM

Handles



PurMop®

MOP HANDLES

Aluminium



SAT2100-K and SAT2150-K are compatible with plastic frames

SAT2100 TELESCOPIC HANDLE | MEDIUM LENGTH

- Autoclavable, suitable for sterile cleanrooms
- Handle grip for ergonomic cleaning
- Quick-change system
- Compatible with stainless steel frames
- Length: 108 cm - 207 cm (adjustable)

Item no. 2131026

ISO	3	4	5	6	7	8
GMP			A/B		C	D

SAT2100-K TELESCOPIC HANDLE | MEDIUM LENGTH

- Autoclavable, suitable for sterile cleanrooms
- Handle grip for ergonomic cleaning
- Quick-change system
- Compatible with plastic frames
- Length: 108 cm - 207 cm (adjustable)

Item no. 2131038

ISO	3	4	5	6	7	8
GMP			A/B		C	D

SAT2150 TELESCOPIC HANDLE | LONG

- Autoclavable, suitable for sterile cleanrooms
- Handle grip for ergonomic cleaning
- Quick-change clip system
- Compatible with stainless steel frames
- Length: 158 cm - 307 cm (adjustable)

Item no. 2131027

ISO	3	4	5	6	7	8
GMP			A/B		C	D

SAT2150-K TELESCOPIC HANDLE | LONG

- Autoclavable, suitable for sterile cleanrooms
- Handle grip for ergonomic cleaning
- Quick-change clip system
- Compatible with plastic frames
- Length: 158 cm - 307 cm (adjustable)

Item no. 2131039

ISO	3	4	5	6	7	8
GMP			A/B		C	D

Highlight

PurMop® mop frames can be used not only for floors. They can be locked into a fixed position for wall and ceiling cleaning.



PurMop®

PLASTIC

Frames & Handles

Ergonomic cleaning at the highest level

PurMop® plastic accessories take ergonomic cleaning to another level and make a strenuous task easy and efficient. Combining light weight with clever functionality, simple length adjustment and touchfree mop handling, this is the cleaning equipment of choice for cleaning operators worldwide.

- Extremely ergonomic and lightweight
- Easy to clean smooth plastic surfaces
- Suitable for floors, walls and ceilings in non-sterile cleanrooms



ergonomic anti-fatigue
handle grip

Length adjustment at the push of a button

This innovative handle allows the adjustment of its length by simply pushing a button. Therefore, the handle is easily adaptable to the size of the user and the cleaning application.

PurMop®

MOP FRAME

Plastic

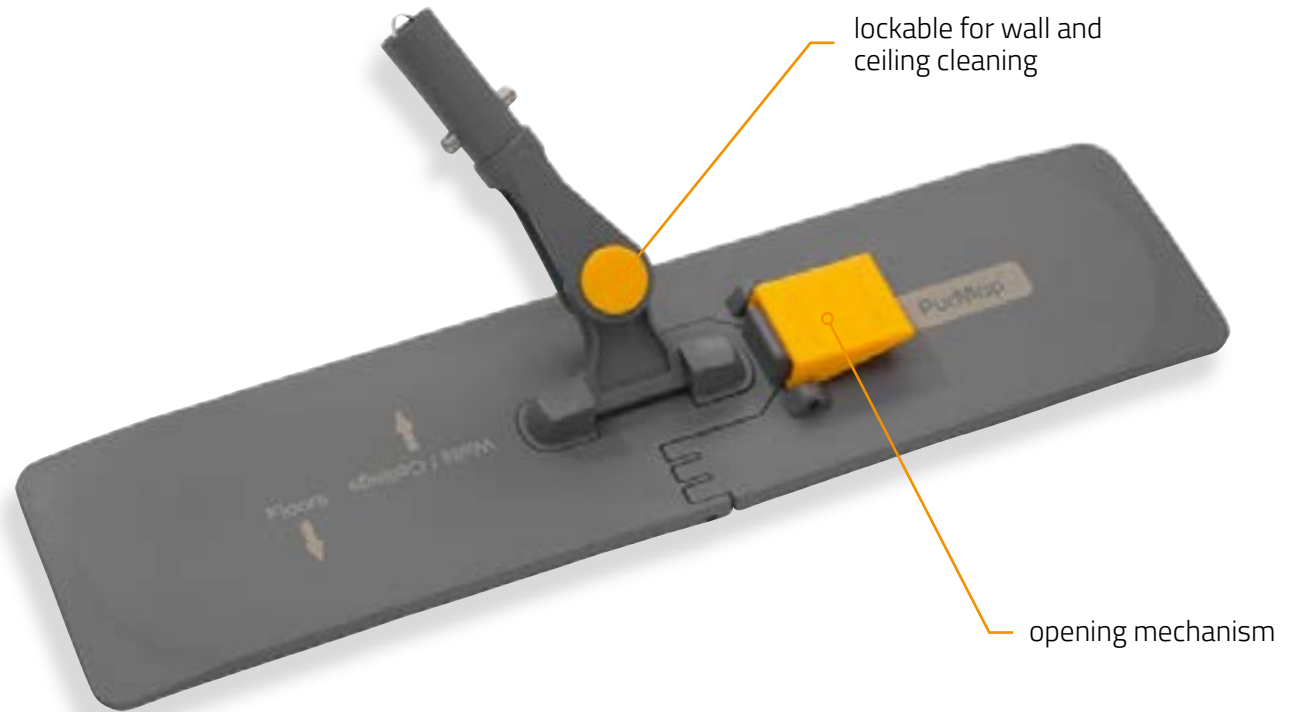

EXTREMELY
LIGHTWEIGHT!

KKV40

FOLDABLE MOP FRAME

- Quick-change system
- Disinfectant resistant
- Smooth, easy to clean plastic
- Compatible with: PurMop® 40 cm mops

Item no. 2151005

ISO	3	4	5	6	7	8
GMP			A/B		C	D



PurMop®

MOP HANDLES

Plastic



SAV150 | fixed



SAK170 | telescopic



SA180 | telescopic



SA400 | telescopic

SAV150 FIXED HANDLE

- Quick-change system
- Disinfectant resistant
- Length: 150 cm

Item no. 2131011

ISO	3	4	5	6	7	8
GMP			A/B		C	D

SAK170 TELESCOPIC HANDLE | MEDIUM LENGTH

- Quick-change system
- Easy length adjustment at the push of a button
- Disinfectant resistant
- Length: 115 cm - 173 cm

Item no. 2131007

ISO	3	4	5	6	7	8
GMP			A/B		C	D

SA180 TELESCOPIC HANDLE | MEDIUM LENGTH

- Quick-change system
- Disinfectant resistant
- Length: 99 cm - 183 cm (adjustable)

Item no. 2131009

ISO	3	4	5	6	7	8
GMP			A/B		C	D

SA400 TELESCOPIC HANDLE | EXTRA LONG

- Quick-change system
- Disinfectant resistant
- Length: 150 cm - 400 cm (adjustable)

Item no. 2131012

ISO	3	4	5	6	7	8
GMP			A/B		C	D



PurMop[®]

ICT

Isolator Cleaning Tools

Special compact cleaning tool for GMP and sterile areas

PurMop® ICT is a special compact cleaning tool for isolators, workbenches and hard to access areas in GMP and sterile cleanrooms. The special design of the short handle and manoeuvrable mop frame makes it very user-friendly. The special disposable mop pads are made of multi-layer polyester material and ensure low particle emission for cleaning and disinfection of critical surfaces.

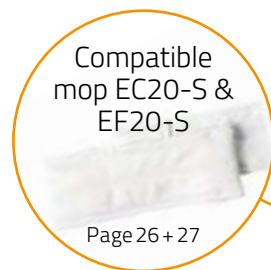

quick-change system

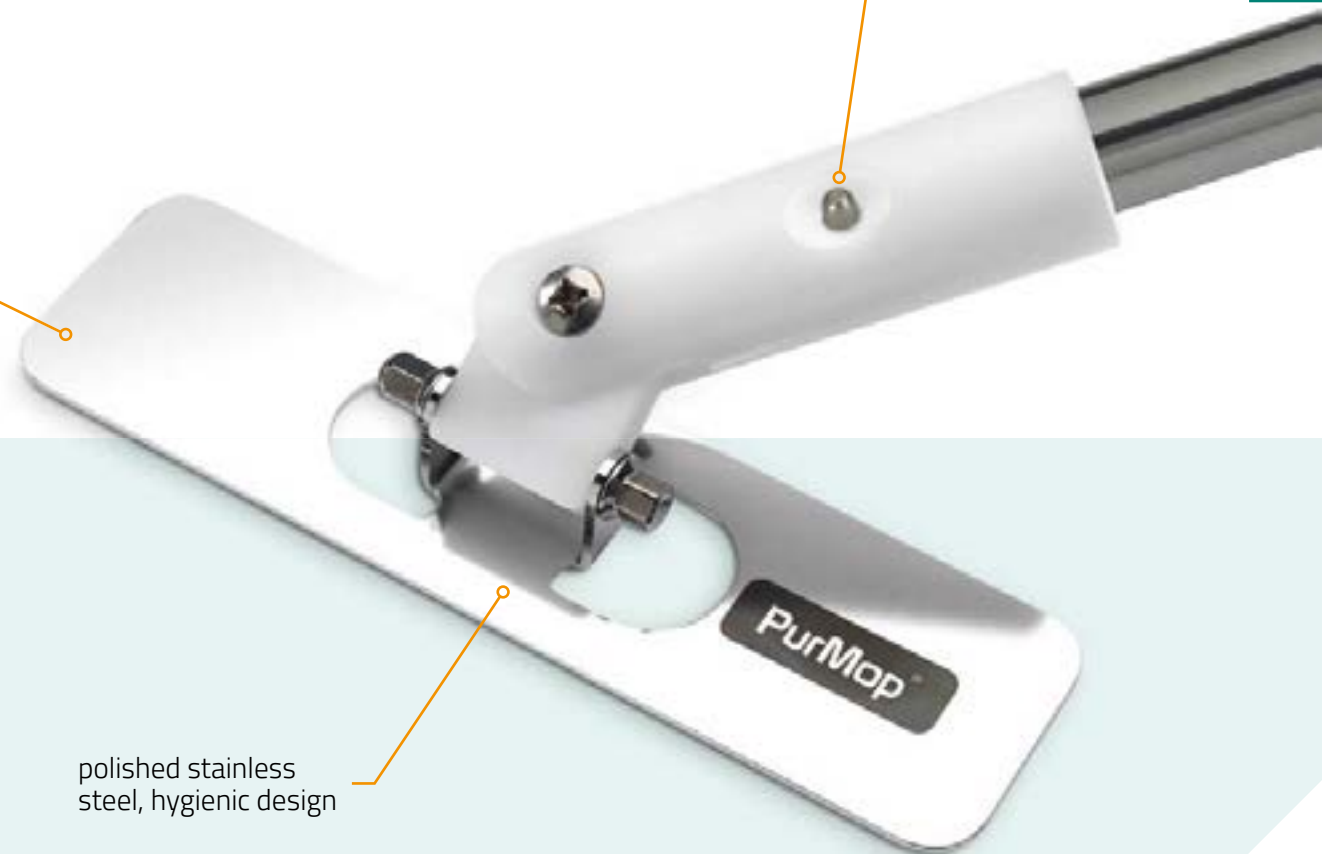

polished stainless steel, hygienic design

Avoid safety risks

The PurMop® ICT tool allows the cleaning operator to effectively access and wipe critical work environments such as isolators and biosafety cabinets safely, without risking cross contamination.

PurMop® ICT SETS

Stainless Steel | Aluminium



ICT2050 | fixed

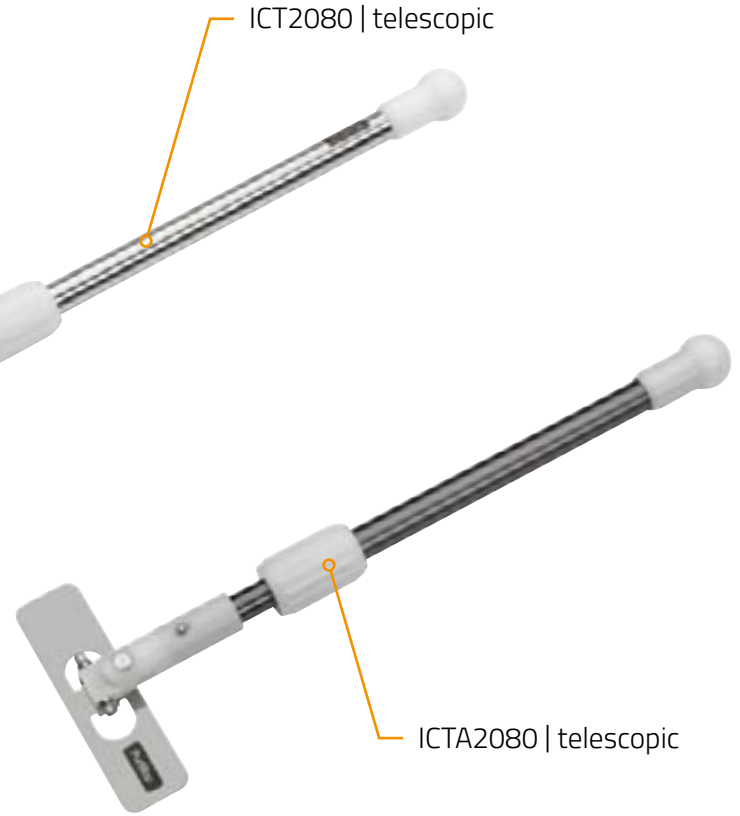

ICT2080 | telescopic

ICTA2080 | telescopic

ICT2050 FIXED ISOLATOR CLEANING TOOL | STAINLESS STEEL

Set, consisting of:

- 1 piece | SEP50 stainless steel fixed handle, 50 cm
- 1 piece | MEP20 stainless steel mop frame, 20 cm
- Robust design, easy to clean
- Autoclavable, suitable for sterile cleanrooms
- Handle grip for ergonomic cleaning
- Quick-change system

Item no. 2131015

ISO	3	4	5	6	7	8
GMP			A/B		C	D

ICT2080 TELESCOPIC ISOLATOR CLEANING TOOL | STAINLESS STEEL

Set, consisting of:

- 1 piece | SET2040 stainless steel telescopic handle, 48 cm - 81 cm
- 1 piece | MEP20 stainless steel mop frame, 20 cm
- Robust design, easy to clean
- Autoclavable, suitable for sterile cleanrooms
- Handle grip for ergonomic cleaning
- Quick-change system

Item no. 2131024

ISO	3	4	5	6	7	8
GMP			A/B		C	D

ICTA2080 TELESCOPIC ISOLATOR CLEANING TOOL | ALUMINIUM

Set, consisting of:

- 1 piece | SAT2040 aluminium telescopic handle, 56 cm - 87 cm
- 1 piece | MEP20 stainless steel mop frame, 20 cm
- Autoclavable, suitable for sterile cleanrooms
- Handle grip for ergonomic cleaning
- Quick-change system

Item no. 2131028

ISO	3	4	5	6	7	8
GMP			A/B		C	D

PurMop®

ICT FRAMES & HANDLES

Stainless Steel | Aluminium



MEP20



SEP50 |
fixed



SET2040 |
telescopic



SAT2040 |
telescopic

MEP20 ICT MOP FRAME | STAINLESS STEEL

- Robust design
- Autoclavable and suitable for sterile cleanrooms
- Quick-change system
- Compatible with: PurMop® 20 cm ICT mops

Item no. 2151006

ISO	3	4	5	6	7	8
GMP			A/B		C	D

SEP50 ICT FIXED MOP HANDLE | STAINLESS STEEL

- Robust design
- Autoclavable and suitable for sterile cleanrooms
- Handle grip for ergonomic cleaning
- Quick-change system
- Length: 52 cm

Item no. 2131013

ISO	3	4	5	6	7	8
GMP			A/B		C	D

SET2040 ICT TELESCOPIC MOP HANDLE | STAINLESS STEEL

- Robust design
- Autoclavable and suitable for sterile cleanrooms
- Handle grip for ergonomic cleaning
- Quick-change system
- Length: 48 cm - 81 cm (adjustable)

Item no. 2131017

ISO	3	4	5	6	7	8
GMP			A/B		C	D

SAT2040 ICT TELESCOPIC MOP HANDLE | ALUMINIUM

- Autoclavable and suitable for sterile cleanrooms
- Handle grip for ergonomic cleaning
- Quick-change system
- Length: 48 cm - 81 cm (adjustable)

Item no. 2131029

ISO	3	4	5	6	7	8
GMP			A/B		C	D

PurMop®

CLEANING TROLLEYS

Engineered in Germany

PurMop® cleaning trolleys are designed to the highest quality standards and specifically for the requirements in cleanroom cleaning. They combine a high level of user-friendliness and efficiency in use, with a modular design and premium stainless steel finishing.

Our cleaning trolleys can be individually configured according to your specific requirements. Thanks to well thought-out functionality, they allow considerable savings on disinfectant and cleaning time.





Mop Dosage System

2.0 ERGO-S	64
2.0 ERGO	66

Ready-2-Use System

GO 200-S	70
GO 200	71

Presaturation System

PREPARE	75
---------	----

Wringer System

UNO	78
DUO	80
TRIO	82



Model
2.0 ERGO-S 230

PurMop®

ERGO

Mop Dosage System

The touchfree cleaning system for cleanrooms

Key advantages of the ERGO-Series:

Touchless performance



Contact with used mop covers and contaminated cleaning equipment is a problem of the past. PurMop® ERGO enables a completely touchless handling of the cleaning trolley in only three steps: 1) pickup, 2) fluid dosing and 3) discarding of the mop.

Reproducible processes

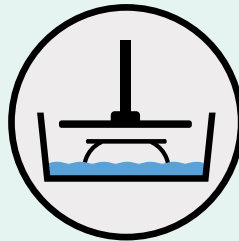

The innovative wetting system enables the application of a defined amount of liquid (detergents / disinfectants) onto the mop in one single step. Discrepancies in the wetting of the mop and operator errors such as reuse of a contaminated mop are effectively prevented.

Advanced ERGOnomics



The ergonomics of a cleaning system can have a significant impact on the effectiveness of the cleaning and disinfection process.
Our answer to that is an uncomplicated, easy-to-use and easy-to-learn system that requires the least effort, eliminates the need for bending down or lifting heavy buckets and eliminates contact with the mop.

Maximum efficiency

40%

Up to 40% less disinfectant /
detergent and water

30%

Up to 30% time saving



Significantly
less effort

Attainable savings with the
ERGO system over against
alternative products
(for instance wringer
systems)

Intelligent fluid dosing – Optimal results in just one step

The ERGO mop wetting unit specifically addresses the challenges of
validatable cleaning equipment. It enables easy and user independent
mop saturation with minimal effort.



Uniquely easy

Mop dosing has never been so simple:
The defined amount of liquid is applied to
the mop in a single activation of the mop
wetting device. After just a few seconds
the mop is evenly saturated. The intelli-
gent dosing avoids the need to wring out
excess liquid.

Precisely SAFE

Defined dosage of liquid, adaptable
according to your requirement with
4 options of dosing plates.



Avoid cross contamination

With the ERGO touch-
free discarding system,
you no longer need
to touch each single
mop. This effectively
prevents the risk of
cross contamination.



The ERGO workflow – simply clever

Bucket 1

1 PICKUP OF A FRESH MOP



The mop carrier enables a fresh mop to be picked up without hand contact.

Bucket 2

2 DOSING – ACTIVATION OF THE MOP WETTING



A defined amount of liquid is applied to the mop and distributed evenly within a few seconds.

3 WIPING



Cleaning or disinfecting the surface (floor / wall / ceiling)

PurMop® cleanroom mops ensure a sufficient and even fluid distribution for optimal cleaning and disinfection.

Bucket 3

4 DISCARDING OF THE USED MOP



The intelligent discarding mechanism enables a touchless discarding of the used mops (either at the front or rear of the trolley).



Watch the „ERGO“ video online:
www.youtube.com/HydroflexEN

PurMop®

2.0 ERGO-S

Mop Dosage System

Stainless Steel



2.0 ERGO-S 200 COMPACT CLEANROOM CLEANING SYSTEM WITH DOSING UNIT

- 1 stainless steel bucket 18 l with mop carrier (right | for new mops)
- 1 stainless steel bucket 18 l with mop wetting device (left | for fluid)
- Dimensions (LxWxH)*: 52 x 61 x 38 cm
- Weight: 16 kg

Item no. 2123028

ISO	3	4	5	6	7	8
GMP			A/B		C	D

2.0 ERGO-S 205-F FOLDABLE CLEANROOM CLEANING SYSTEM WITH DOSING UNIT

- 1 stainless steel bucket 18 l with mop carrier (front | for new mops)
- 1 stainless steel bucket 18 l with mop wetting device (center | for fluid)
- Waste bag holder with clips, for MB18-R/S (rear | for mop discarding)
- Stainless steel discarding mechanism
- With handle holder (side)
- Dimensions (LxWxH)*: 65 x 70 x 94 cm
- Collapsed height: 72 cm
- Weight: 20 kg

Item no. 2123030

ISO	3	4	5	6	7	8
GMP			A/B		C	D

2.0 ERGO-S 210 CLEANROOM CLEANING SYSTEM WITH DOSING UNIT

- 1 stainless steel bucket 18 l with mop carrier (front | for new mops)
- 1 stainless steel bucket 18 l with mop wetting device (center | for fluid)
- 1 stainless steel bucket 18 l (rear | for mop discarding)
- Stainless steel discarding mechanism
- Handle holder (side) and waste bag holder (rear)
- Dimensions (LxWxH)*: 65 x 70 x 97 cm
- Weight: 25 kg

Item no. 2123021

ISO	3	4	5	6	7	8
GMP			A/B		C	D

OUR BESTSELLER



2.0 ERGO-S 230 CLEANROOM CLEANING SYSTEM WITH DOSING UNIT

- 1 stainless steel bucket 18 l with mop carrier (front | for new mops)
- 1 stainless steel bucket 18 l with mop wetting device (center | for fluid)
- 1 stainless steel bucket 18 l (rear | for mop discarding)
- 2 stainless steel buckets each 5 l (above | for storage)
- Stainless steel discarding mechanism
- Handle holder (side) and waste bag holder (rear)
- Dimensions (LxWxH)*: 65 x 70 x 102 cm
- Weight: 27 kg

Item no. 2123022

ISO	3	4	5	6	7	8
GMP			A/B		C	D

2.0 ERGO-S 300 CLEANROOM CLEANING SYSTEM WITH DOSING UNIT

- 1 stainless steel bucket 18 l with mop carrier (front | for new mops)
- 1 stainless steel bucket 18 l with mop wetting device (center | for fluid)
- 1 stainless steel bucket 18 l (for mop discarding)
- Stainless steel discarding mechanism
- Handle holder (side) and waste bag holder
- Dimensions (LxWxH)*: 78 x 70 x 97 cm
- Weight: 25 kg

Item no. 2123023

ISO	3	4	5	6	7	8
GMP			A/B		C	D

2.0 ERGO-S 320 CLEANROOM CLEANING SYSTEM WITH DOSING UNIT

- 1 stainless steel bucket 18 l with mop carrier (front | for new mops)
- 1 stainless steel bucket 18 l with mop wetting device (center | for fluid)
- 1 stainless steel bucket 18 l (for mop discarding)
- 2 stainless steel buckets each 5 l (above | for storage)
- Stainless steel discarding mechanism
- Handle holder (side) and waste bag holder
- Dimensions (LxWxH)*: 78 x 70 x 102 cm
- Weight: 27 kg

Item no. 2123025

ISO	3	4	5	6	7	8
GMP			A/B		C	D

PurMop® 2.0 ERGO

Mop Dosage System

Plastic



2.0 ERGO 200 COMPACT CLEANROOM CLEANING SYSTEM WITH DOSING UNIT

- 1 plastic bucket 18 l with mop carrier (right | for new mops)
- 1 plastic bucket 18 l with mop wetting device (left | for fluid)
- Dimensions (LxWxH)*: 50 x 60 x 42 mm
- Weight: 10 kg

Item no. 2123027

ISO	3	4	5	6	7	8
GMP			A/B		C	D

2.0 ERGO 205-F FOLDABLE CLEANROOM CLEANING SYSTEM WITH DOSING UNIT

- 1 plastic bucket 18 l with mop carrier (front | for new mops)
- 1 plastic bucket 18 l with mop wetting device (center | for fluid)
- Waste bag holder with clips for MB18-R/S (rear | for mop discarding)
- Stainless steel discarding mechanism
- Handle holder (side)
- Dimensions (LxWxH)*: 65 x 70 x 96 cm
- Collapsed height: 72 cm
- Weight: 14 kg

Item no. 2123029

ISO	3	4	5	6	7	8
GMP			A/B		C	D

2.0 ERGO 210 CLEANROOM CLEANING SYSTEM WITH DOSING UNIT

- 1 plastic bucket 18 l with mop carrier (front | for new mops)
- 1 plastic bucket 18 l with mop wetting device (center | for fluid)
- 1 plastic bucket 18 l (rear | for mop discarding)
- Stainless steel discarding mechanism
- Handle holder (side) and waste bag holder (rear)
- Dimensions (LxWxH)*: 65 x 70 x 98 cm
- Weight: 17 kg

Item no. 2123015

ISO	3	4	5	6	7	8
GMP			A/B		C	D



**2.0 ERGO 230
CLEANROOM CLEANING SYSTEM WITH DOSING
UNIT**

- 1 plastic bucket 18 l with mop carrier (front | for new mops)
- 1 plastic bucket 18 l with mop wetting device (center | for fluid)
- 1 plastic bucket 18 l (rear | for mop discarding)
- 2 plastic buckets each 6 l (above | for storage)
- Stainless steel discarding mechanism
- Handle holder (side) and waste bag holder (rear)
- Dimensions (LxWxH)*: 65 x 70 x 105 cm
- Weight: 18 kg

Item no. 2123016

ISO	3	4	5	6	7	8
GMP			A/B		C	D



**2.0 ERGO 300
CLEANROOM CLEANING SYSTEM WITH DOSING
UNIT**

- 1 plastic bucket 18 l with mop carrier (front | for new mops)
- 1 plastic bucket 18 l with mop wetting device (center | for fluid)
- 1 plastic bucket 18 l (for mop discarding)
- Stainless steel discarding mechanism
- Handle holder (side) and waste bag holder
- Dimensions (LxWxH)*: 78 x 70 x 98 cm
- Weight: 16 kg

Item no. 2123017

ISO	3	4	5	6	7	8
GMP			A/B		C	D



**2.0 ERGO 320
CLEANROOM CLEANING SYSTEM WITH DOSING
UNIT**

- 1 plastic bucket 18 l with mop carrier (front | for new mops)
- 1 plastic bucket 18 l with mop wetting device (center | for fluid)
- 1 plastic bucket 18 l (for mop discarding)
- 2 plastic buckets each 6 l (above | for storage)
- Stainless steel discarding mechanism
- Handle holder (side) and waste bag holder
- Dimensions (LxWxH)*: 78 x 70 x 105 cm
- Weight: 18 kg

Item no. 2123019

ISO	3	4	5	6	7	8
GMP			A/B		C	D



PurMop®

GO

Trolley for Ready-2-Use Mops

Safe to use – Easy to store

The cleaning trolleys of the PurMop® GO-Series are designed for use with PurMop® Ready-2-Use or presaturated mops. These mops already contain the required amount of fluid in the product packaging, therefore eliminating the need to dose the liquid in the trolley.

To ensure a safe handling of the presaturated mops and facilitate touchfree mop pick up and discarding after use. The GO-Series trolleys offer a simple but effective solution.

Special features:

- For usage with presaturated / Ready-2-Use mops
- With foldable handle for space-saving storage
- Polished stainless steel surfaces, fully autoclavable
- Non-abrasive and electrostatically conductive castors
- Touchless handling with mop discarding mechanism

Usage

Place the presaturated mops into the first bucket. Pick up a fresh mop and start wiping. Discard used mop after wiping into the mop waste bag.



Storage

After usage, clean the buckets, discard waste bag, fold trolley handle and store in designated place.



Presaturated &
Ready-2-Use mops



Watch the „GO“ video online:
www.youtube.com/HydroflexEN

PurMop® GO-S 200

Trolley for Ready-2-Use Mops

Stainless Steel



GO-S 200 COMPACT CLEANROOM CLEANING TROLLEY

- 1 stainless steel bucket 18 l with mop carrier (right | for presaturated mops)
- 1 stainless steel bucket 18 l (left | for used mops)
- Dimensions (LxWxH)*: 52 x 61 x 38 cm
- Weight: 13 kg

Item no. 2126102

ISO	3	4	5	6	7	8
GMP			A/B		C	D

GO-S 200-F FOLDABLE CLEANROOM CLEANING TROLLEY

- 1 stainless steel bucket 18 l with mop carrier (front | for presaturated mops)
- Waste bag holder with clips, for MB18-R/S (center | for mop discarding)
- Stainless steel discarding mechanism
- Handle holder (side)
- Dimensions (LxWxH)*: 57 x 70 x 95 cm
- Collapsed height: 72 cm
- Weight: 14 kg

Item no. 2126103

ISO	3	4	5	6	7	8
GMP			A/B		C	D

FULLY
AUTOCLAVABLE

PurMop®
**GO
200**

Trolley for Ready-2-Use Mops
Plastic



**GO 200
COMPACT CLEANROOM CLEANING
TROLLEY**

- 1 plastic bucket 18 l with mop carrier (right | for presaturated mops)
- 1 plastic bucket 18 l (left | for used mops)
- Dimensions (LxWxH)*: 51 x 60 x 42 cm
- Weight: 7 kg

Item no. 2126100

ISO	3	4	5	6	7	8
GMP			A/B		C	D

**GO 200-F
FOLDABLE CLEANROOM CLEANING TROLLEY**

- 1 plastic bucket 18 l with mop carrier (front | for presaturated mops)
- Waste bag holder with clips, for MB18-R/S (center | for mop discarding)
- Stainless steel discarding mechanism
- Handle holder (side)
- Dimensions (LxWxH)*: 57 x 70 x 96 cm
- Weight: 11 kg

Item no. 2126101

ISO	3	4	5	6	7	8
GMP			A/B		C	D

**MB18-R | MB18-RS
CLEANROOM WASTE BAG | STERILE**

- Fits ERGO bucket / bag holder
- For discarding and disposal of used mops
- Available in sterile version
- Size (LxWxH): 585 x 185 x 500 mm
- Thickness 0.075 mm, bottom seam
- Packing: 5 pieces / double bag, 20 bags / carton [case = 100 pcs]

MB18-R: Item no. 2130002

MB18-RS: Item no. 2130001





PurMop®

PREPARE

Presaturation System

Easy presaturation of mops

The PREPARE stainless steel presaturation system is an ultra compact and mobile cleaning system for presaturating mops and has a 2-bucket design. By pouring cleaning / disinfecting fluid over the mops in the bucket, these can be easily and safely saturated before usage. One bucket is for picking up the fresh mops, the other is intended to discard the used mops.

PurMop® PREPARE is made entirely of stainless steel, is easy to clean and fully autoclavable. Thanks to its simple and modular design, it is easy to take apart and can be used as a stand-alone system or added to a trolley for enhanced capacity.

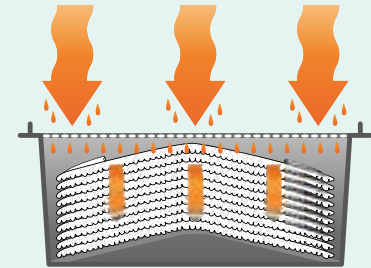

The perforation of the sieve distributes the fluid evenly over the mops. Saturation is achieved after just a few minutes.

ULTRA COMPACT

Due to its small dimensions, PREPARE is perfectly suited for small cleanrooms and is easy to stow.

Presaturation System – how it works

Pre-preparation is a simple method for saturating cleanroom mops with fluid before the cleaning process. The „conventional“ wringing in a flat wringer is no longer necessary. This is how it works:

1 LOAD BUCKET WITH FRESH MOPS



Before starting the cleaning process, select the required dry mop quantity and place them into bucket no. 1.

2 PREPARE FLUID



Fill the required fluid amount into the scaled bucket no. 2.

3 SATURATE THE MOPS



Place dosage sieve on bucket no. 1 (containing the mops). Pour the fluid into the dosage sieve and wait some minutes to achieve an even wetting of all mops.

4 ATTACH A PRESATURATED MOP



Presaturated mops can be individually removed from the mop bucket no. 1. The specially designed mop carrier simplifies picking up the mops without hand contact.

5 DISCARD THE USED MOP



After the wiping process, used mops are discarded into bucket no. 2. Cross-contamination is avoided by the separation of fresh and used (contaminated) mops.

PurMop®

PREPARE

Presaturation System

Stainless Steel



PREPARE COMPACT PRESATURATION SYSTEM

- 2 x 8.5 l buckets with handles
- Stainless steel sieve for fluid dosage
- Mop carrier for easy pickup of mops
- Ideal for disposable mops
- Dimensions (LxWxH)*: 53 x 32 x 31 cm
- Weight: 8 kg

Item no. 2124001

ISO	3	4	5	6	7	8
GMP			A/B		C	D

PREPARE 311 PRESATURATION SYSTEM WITH TROLLEY

- 2 x 8.5 l buckets with handles
- 2 extra buckets each 8.5 l in the rear for used mops
- Stainless steel sieve for fluid dosage
- Mop carrier for easy pickup of mops
- Stainless steel castors (grease-free), two with brake
- Dimensions (LxWxH)*: 58 x 59 x 90 cm
- Weight: 18 kg

Item no. 2126002

ISO	3	4	5	6	7	8
GMP			A/B		C	D

* assembled sizes



PurMop®

UNO/ DUO/TRIO

Wringer System

Trolleys with stainless steel wringer

With our PurMop® UNO, DUO and TRIO-Series we offer a wide range of cleaning trolleys with wringer, from compact single bucket to triple bucket systems and in stainless steel or plastic material. Wringer systems can be used for various cleaning tasks, such as 2-stage mopping as well as cleaning with detergent and disinfectant or disinfection without mop change.

Features of our wringer systems:

- Large selection of models, the right system for every application
- Made of stainless steel with polished surfaces
- Fully autoclavable and disinfectant resistant
- Modular design, easy to add or replace accessory parts and buckets



Easy to use – optimal wringing results

1) Press stop

- The press stop of the wringer ensures that the same amount of force is applied for every usage. This enables reproducible dosage results.

2) Force transfer support

- The special force transfer mechanism allows more wringing pressure to be applied to the mop with less user exertion.

3) Full stainless steel design

- Special sleeve bearings for less abrasion
- Easy to take apart and clean

PurMop®

UNO

Wringer System

Stainless Steel

INFO

Buckets on the rear are for storage of fresh / used mops



UNO 100 CLEANROOM CLEANING SYSTEM WITH WRINGER | SINGLE BUCKET

- 1 stainless steel bucket 26 l (front)
- Stainless steel wringer
- Dimensions (LxWxH)*: 50 x 59 x 90 cm
- Weight: 16 kg

Item no. 2121100

ISO	3	4	5	6	7	8
GMP			A/B		C	D

* assembled sizes



UNO 111
CLEANROOM CLEANING SYSTEM WITH WRINGER |
SINGLE BUCKET

- 1 stainless steel bucket 26 l (front)
- 2 stainless steel buckets 8.5 l (rear)
- 1 stainless steel wringer
- Dimensions (LxWxH)*: 58 x 59 x 90 cm
- Weight: 20 kg

Item no. 2121103

ISO	3	4	5	6	7	8
GMP			A/B		C	D



UNO 200
CLEANROOM CLEANING SYSTEM WITH WRINGER |
DOUBLE BUCKET

- 2 stainless steel buckets 8.5 l (front)
- Stainless steel wringer
- Dimensions (LxWxH)*: 50 x 59 x 90 cm
- Weight: 16 kg

Item no. 2121200

ISO	3	4	5	6	7	8
GMP			A/B		C	D



UNO 211
CLEANROOM CLEANING SYSTEM WITH WRINGER |
DOUBLE BUCKET

- 2 stainless steel buckets 8.5 l (front)
- 2 stainless steel buckets 8.5 l (rear)
- Stainless steel wringer
- Dimensions (LxWxH)*: 58 x 59 x 90 cm
- Weight: 21 kg

Item no. 2121203

ISO	3	4	5	6	7	8
GMP			A/B		C	D

PurMop® DUO

Wringer System

Stainless Steel

INFO

Buckets on the rear are for storage of fresh / used mops



DUO 200 CLEANROOM CLEANING SYSTEM WITH WRINGER | DOUBLE BUCKET

- 2 stainless steel buckets 26 l (front)
- Stainless steel wringer
- Dimensions (LxWxH)*: 80 x 59 x 98 cm
- Weight: 19 kg

Item no. 2122100

ISO	3	4	5	6	7	8
GMP			A/B		C	D

* assembled sizes



DUO 211
CLEANROOM CLEANING SYSTEM WITH WRINGER |
DOUBLE BUCKET

- 2 stainless steel buckets 26 l (front)
- 2 stainless steel buckets 8.5 l (rear)
- Stainless steel wringer
- Dimensions (LxWxH)*: 90 x 59 x 98 cm
- Weight: 24 kg

Item no. 2122103

ISO	3	4	5	6	7	8
GMP			A/B		C	D



DUO 300
CLEANROOM CLEANING SYSTEM WITH WRINGER |
TRIPLE BUCKET

- 1 stainless steel bucket 26 l (front)
- 2 stainless steel buckets 8.5 l (front)
- Stainless steel wringer
- Dimensions (LxWxH)*: 80 x 59 x 98 cm
- Weight: 22 kg

Item no. 2122109

ISO	3	4	5	6	7	8
GMP			A/B		C	D



DUO 311
CLEANROOM CLEANING SYSTEM WITH WRINGER |
TRIPLE BUCKET

- 1 stainless steel bucket 26 l (front)
- 2 stainless steel buckets 8.5 l (front)
- 2 stainless steel buckets 8.5 l (rear)
- Stainless steel wringer
- Dimensions (LxWxH)*: 90 x 59 x 98 cm
- Weight: 26 kg

Item no. 2122110

ISO	3	4	5	6	7	8
GMP			A/B		C	D

PurMop® TRIO

Wringer System

Stainless Steel / Plastic

ADVANTAGES with PurMop® TRIO:

- On-board mop storage
- Touchfree handling with discarding system
- Handle and waste bag holder included



2.0 TRIO-S 210 CLEANROOM CLEANING SYSTEM WITH WRINGER | SINGLE BUCKET

- 1 stainless steel bucket 18 l with mop carrier (front | for new mops)
- 1 stainless steel bucket 18 l (center | for fluid)
- 1 stainless steel bucket 18 l (rear | for mop discarding)
- Stainless steel wringer
- Stainless steel discarding mechanism
- Handle holder (side) and waste bag holder (rear)
- Plaque for individual marking
- Dimensions (LxWxH)*: 65 x 70 x 97 cm
- Weight: 28 kg

Item no. 2125109

ISO	3	4	5	6	7	8
GMP			A/B		C	D

2.0 TRIO-S 230 CLEANROOM CLEANING SYSTEM WITH WRINGER | SINGLE BUCKET

- 1 stainless steel bucket 18 l with mop carrier (front | for new mops)
- 1 stainless steel bucket 18 l (center | for fluid)
- 1 stainless steel bucket 18 l (rear | for mop discarding)
- 2 stainless steel buckets each 5 l (top | for storage)
- Stainless steel wringer
- Stainless steel discarding mechanism
- Handle holder (side) and waste bag holder (rear)
- Plaque for individual marking
- Dimensions (LxWxH)*: 65 x 70 x 103 cm
- Weight: 31 kg

Item no. 2125110

ISO	3	4	5	6	7	8
GMP			A/B		C	D

2.0 TRIO-S 240 CLEANROOM CLEANING SYSTEM WITH WRINGER | DOUBLE BUCKET

- 2 stainless steel buckets each 18 l (front | for fluid)
- 1 stainless steel bucket 18 l (rear | for mop discarding)
- Mop holder with mop carrier (top | for new mops)
- Stainless steel wringer
- Stainless steel discarding mechanism
- Handle holder (side) and waste bag holder (rear)
- Plaque for individual marking
- Dimensions (LxWxH)*: 65 x 70 x 97 cm
- Weight: 29 kg

Item no. 2125111

ISO	3	4	5	6	7	8
GMP			A/B		C	D

* assembled sizes



2.0 TRIO-S 340 CLEANROOM CLEANING SYSTEM WITH WRINGER | TRIPLE BUCKET

- 3 stainless steel buckets each 18 l (front | for fluid)
- 1 stainless steel bucket 18 l (rear | for mop discarding)
- Mop holder with mop carrier (top | for new mops)
- Stainless steel wringer
- Stainless steel discarding mechanism
- Handle holder (side) and waste bag holder (rear)
- Plaque for individual marking
- Dimensions (LxWxH)*: 83 x 70 x 97 cm
- Weight: 33 kg

Item no. 2125116

ISO	3	4	5	6	7	8
GMP			A/B		C	D



2.0 TRIO 310 CLEANROOM CLEANING SYSTEM WITH WRINGER | DOUBLE BUCKET

- 1 plastic bucket 18 l with mop carrier (front | for new mops)
- 2 plastic buckets each 18 l (center | for fluid)
- 1 plastic bucket 18 l (rear | for mop discarding)
- Stainless steel wringer
- Stainless steel discarding mechanism
- Handle holder (side) and waste bag holder (rear)
- Plaque for individual marking
- Dimensions (LxWxH)*: 83 x 70 x 98 cm
- Weight: 21 kg

Item no. 2125105

ISO	3	4	5	6	7	8
GMP			A/B		C	D



2.0 TRIO 330 CLEANROOM CLEANING SYSTEM WITH WRINGER | DOUBLE BUCKET

- 1 plastic bucket 18 l with mop carrier (front | for new mops)
- 2 plastic buckets each 18 l (center | for fluid)
- 1 plastic bucket 18 l (rear | for mop discarding)
- 2 plastic buckets each 6 l (top | for storage)
- 1 stainless steel wringer
- Stainless steel discarding mechanism
- Handle holder (side) and waste bag holder (rear)
- Plaque for individual marking
- Dimensions (LxWxH)*: 83 x 70 x 105 cm
- Weight: 23 kg

Item no. 2125107

ISO	3	4	5	6	7	8
GMP			A/B		C	D

PurMop®

WRINGER SYSTEM

User Guide

Definition of the cleaning area

The cleaning area per mop must be defined in advance. This specific area must not be exceeded while cleaning and disinfecting. Through the definition of the maximum area, an adequate surface wetting can be guaranteed.

Mop change method

Single and double bucket systems are operated with the mop change method. Each mop is wetted and used for a surface only once. After wiping the predefined area (approx. 10 - 20 m² depending on surface), the used mop is replaced. Contact between the used mop and the fresh fluid should be strictly avoided, due to the risk of cross contamination!

Single bucket system

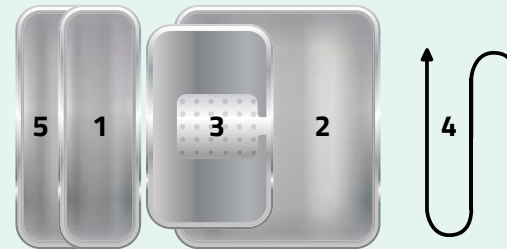

Schematic view of UNO 111 from above

1. Pick up a new mop (bucket 1)
2. Completely soak mop in the fresh fluid (bucket 2)
3. Wring the mop (wringer 3) while attached to the mop frame to remove excess fluid. Hold for appr. 10 seconds. Wrung fluid runs into bucket 2
4. Wipe the floor using s-curve method, until the mop has reached the maximum surface coverage
5. Remove the used mop (bucket 5) and start with step 1

Advantages:

- _ Smaller trolley size, easier to store
- _ No risk of cross contamination due to mop change method

Recommended for:

- _ One stage wiping
- _ Disinfection of surfaces
- _ One type of fluid on board
- _ Only in combination with with mop change (see step 5)

Double bucket system



Schematic view of DUO 211 from above

1. Pick up a new mop (bucket 1)
2. Completely soak mop in the fresh fluid (bucket 2b)
3. Wring the mop (wringer 3) while attached to the mop frame to remove excess fluid. Hold for appr. 10 seconds. Wrung fluid runs into bucket 2a
4. Wipe the floor using s-curve method, until the mop has reached the maximum surface coverage
5. Remove the used mop (bucket 5) and start with step 1

Advantages:

- _ Safely separates fresh and wrung fluid
- _ More flexibility, can load 2 fluids on the trolley

Recommended for:

- _ One stage or two stage wiping
- _ Cleaning or disinfection of surfaces
- _ Up to 2 types of fluids on board
- _ Only in combination with mop change (see step 5)

Triple bucket system

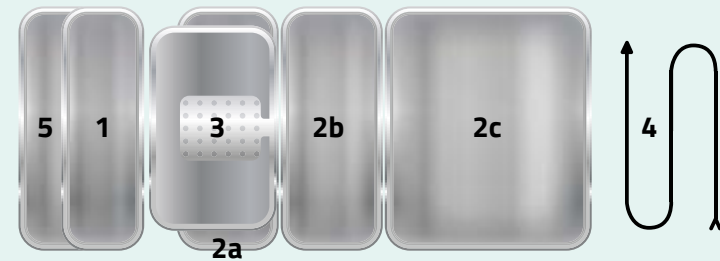

Schematic view of DUO 311 from above

1. Pick up a new mop (bucket 1)
2. Completely soak mop in the fresh fluid (bucket 2c)
3. Wring the mop (wringer 3) while attached to the mop frame to remove excess fluid. Hold for appr. 10 seconds. Wrung fluid runs into bucket 2a
4. Wipe the floor using s-curve method, until the mop has reached the maximum surface coverage
5. Rinse the used mop in rinsing water (bucket 2b) and wring the mop (wringer 3). Then continue with step 2
6. Remove the used mop (bucket 5) after disinfection is completed or mop requires replacement

Advantages:

- _ Wipe a larger surface with one mop
- _ More flexibility, for larger cleanrooms

Recommended for:

- _ One stage or two stage wiping
- _ Disinfection of surfaces only
- _ Without mop change (see step 5)

Hydroflex

PurWipe®
**CLEANROOM
WIPES**

A pure choice for critical surfaces



Pure wipes for every cleanroom application

The PurWipe® range of premium cleanroom wipes is developed to fulfil the high requirements in disinfection and decontamination of critical cleanroom surfaces. Compliance is ensured through continuous quality control in manufacturing as well as full validation and testing by in-house laboratories and independent test institutes.

Disposable Wipes

Dry N-Series, nonwoven	88
Dry K-Series, knit	92
Presaturated V-Series	98
Packaging concept	102

Reusable Wipes

PurWipe® Microfiber	104
SaniWipe® Microfiber	107



PurWipe®

N-SERIES

Nonwoven Wipes | dry

Nonwoven Cleanroom Wipes

The cost efficient option for basic applications and non-critical surfaces

PurWipe® N-Series cleanroom wipes consist of bonded nonwoven materials and are suitable for a wide range of applications - from disinfection to surface cleaning. They are designed to be used in cleanrooms with lower classification and non-sterile areas. Nonwoven wipes boast a high absorbency along with a good price-performance ratio.

Features of our nonwoven wipes:

- Consist of bonded staple fibers or meltblown material
- Ensure good fluid absorption
- Low cost solution
- Basic processing without decontamination

Product identification

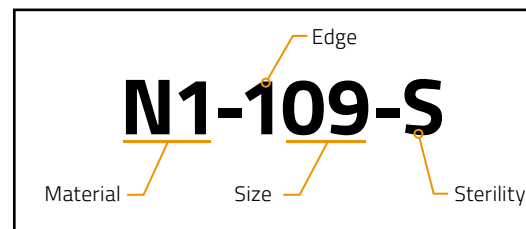

Available edge sealing options



PurWipe® N1

Cleanroom Wipe

Polyester-Cellulose

Nonwoven

PurWipe® N1 polyester-cellulose nonwoven wipes consist of a high-quality, hydroentangled nonwoven material. Thanks to the high fluid absorption capacity they are ideal for the disinfection of smooth surfaces and for absorbing of fluids.

The nonwoven structure removes loose dirt and makes the wipe ideal for general applications in cleanrooms with lower classification.

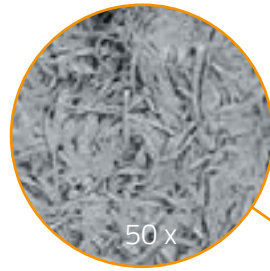

55%
Cellulose
45%
Polyester

68g/m²

Optionally available in other sizes and as Basic Line

N1-109

- Size: 23 x 23 cm | 9 x 9"
- Edges: Cut
- Packaging:
300 pcs / bag (pack),
10 packs / carton
[case = 3,000 pcs]

Item no. 2183100

ISO	3	4	5	6	7	8
GMP			A/B		C	D

N1-112

- Size: 30 x 30 cm | 12 x 12"
- Edges: Cut
- Packaging:
300 pcs / bag (pack),
10 packs / carton
[case = 3,000 pcs]

Item no. 2183102

N1-109-S [STERILE]

- Size: 23 x 23 cm | 9 x 9"
- Edges: Cut
- Packaging:
20 pcs / bag, 10 bags (pack),
10 packs / carton
[case = 2,000 pcs]

Item no. 2183101

ISO	3	4	5	6	7	8
GMP			A/B		C	D

N1-112-S [STERILE]

- Size: 30 x 30 cm | 12 x 12"
- Edges: Cut
- Packaging:
20 pcs / bag, 10 bags (pack),
10 packs / carton
[case = 2,000 pcs]

Item no. 2183103

- High absorbency
- Suitable for general cleaning tasks
- Recommended for non-critical applications

PurWipe® N2

Cleanroom Wipe

Polyester-Polyamide-
Microfiber Nonwoven

The innovative PurWipe® N2 cleanroom nonwoven wipe consists of a polyester-polyamide-microfiber material. The ultrafine microfibers ensure good fluid absorbency as well as a high cleaning ability and optimal removal of tiny particles on all types of surfaces.

Thanks to its superior tear resistance and fully synthetic material, the N2 wipe is ideally suited for a broad range of applications.

INNOVATION

- Highly durable and tear resistant
- Highest cleaning ability due to microfibers
- No natural fibers, consist of 100 % synthetic material

Optionally available in other sizes and as Basic Line

N2-109

- Size: 23 x 23 cm | 9 x 9"
- Edges: Cut
- Packaging:
100 pcs / bag (pack),
20 packs / carton
[case = 2,000 pcs]

Item no. 2183500

ISO	3	4	5	6	7	8
GMP			A/B		C	D

N2-112

- Size: 30 x 30 cm | 12 x 12"
- Edges: Cut
- Packaging:
100 pcs / bag (pack),
20 packs / carton
[case = 2,000 pcs]

Item no. 2183502

N2-109-S [STERILE]

- Size: 23 x 23 cm | 9 x 9"
- Edges: Cut
- Packaging:
20 pcs / bag, 10 bags (pack),
10 packs / carton
[case = 2,000 pcs]

Item no. 2183501

ISO	3	4	5	6	7	8
GMP			A/B		C	D

N2-112-S [STERILE]

- Size: 30 x 30 cm | 12 x 12"
- Edges: Cut
- Packaging:
20 pcs / bag, 10 bags (pack),
10 packs / carton
[case = 2,000 pcs]

Item no. 2183503

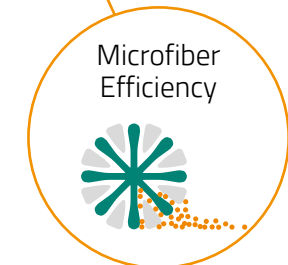
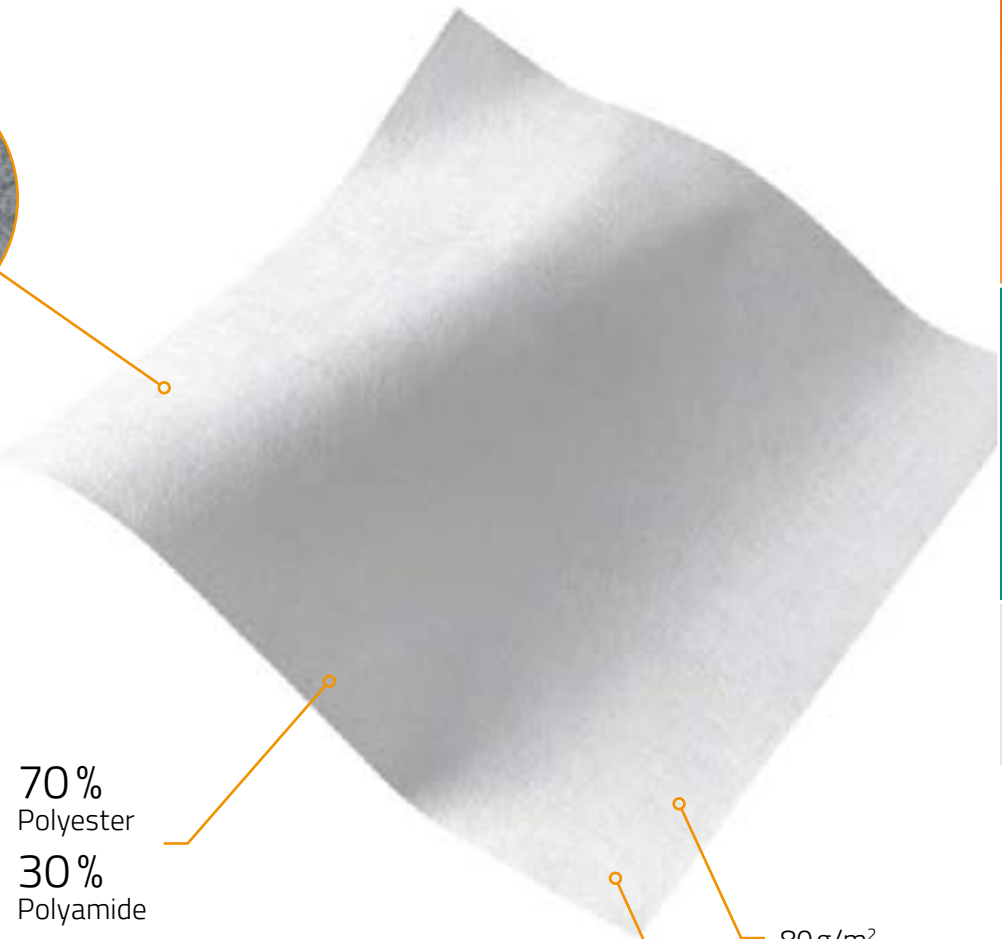
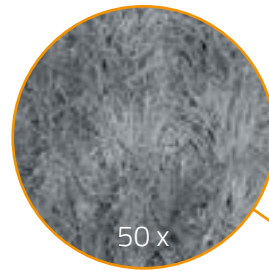

Premium Wipes

High purity and ideal
cleaning performance.



PurWipe®

K-SERIES

Knitted Wipes | dry

Knitted Cleanroom Wipes

Maximum cleanliness and durability for critical applications

In any cleanroom, knitted wipes are the basis for a safe cleaning and disinfection process on sensitive and critical surfaces. They consist of synthetic fibers, are pre-washed and emit only low levels of particles. PurWipe® knitted wipes are available with different edge sealing options, as well as in various sizes and material weights, thus offering the right solution for every application.

Features of our knitted wipes:

- Consist of continuous filaments
- Made from 100 % synthetic fibers
- Good chemical and mechanical resistance
- Pre-washed multiple times with ultrapure water
- Ensure consistently low particle emission
- Ideal for use in critical production areas

Product identification

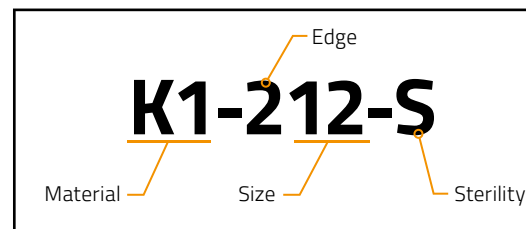

Available edge sealing options

1
Laser cut



2
Heat sealed



3
Ultrasonic sealed



PurWipe® K1

Cleanroom Wipe
Polyester Knit

The K1 polyester wipe is designed for a wide range of applications. It comprises of a high-quality double-knit material boasting good absorbency and durability.

Due to its two-dimensional structure the K1 removes even tough residues and contaminants from surfaces of all kinds. The heat sealed edges along with the special decontamination process ensure very low particle emission.



50 x

edge
heat sealed

100%
Polyester

145g/m²

Optionally available in other edges, sizes and as Basic Line

K1-209

- Size: 23 x 23 cm | 9 x 9"
- Edges: Heat sealed
- Packaging:
150 pcs / bag (pack),
10 packs / carton
[case = 1,500 pcs]

Item no. 2183202

ISO	3	4	5	6	7	8
GMP			A/B		C	D

K1-212

- Size: 30 x 30 cm | 12 x 12"
- Edges: Heat sealed
- Packaging:
150 pcs / bag (pack),
10 packs / carton
[case = 1,500 pcs]

Item no. 2183204

K1-209-S [STERILE]

- Size: 23 x 23 cm | 9 x 9"
- Edges: Heat sealed
- Packaging:
10 pcs / bag, 10 bags (pack),
10 packs / carton
[case = 1,000 pcs]

Item no. 2183203

ISO	3	4	5	6	7	8
GMP			A/B		C	D

K1-212-S [STERILE]

- Size: 30 x 30 cm | 12 x 12"
- Edges: Heat sealed
- Packaging:
10 pcs / bag, 10 bags (pack),
10 packs / carton
[case = 1,000 pcs]

Item no. 2183205

- High absorbency and good general cleaning ability
- Pre-washed with ultrapure water
- Optimal for general cleaning and disinfection of critical cleanroom surfaces

PurWipe® K2

Cleanroom Wipe
Polyester-Microfiber Knit

The PurWipe® K2 is a pure polyester microfiber wipe with a fine knit structure and soft texture, making it ideal for use on scratch-sensitive surfaces such as glass. The fine microfibers remove even the smallest particles without damaging the surface. If required, the K2 is also available as 4" or 6" wipe, making it ideal for cleaning of small mechanical or optical components.

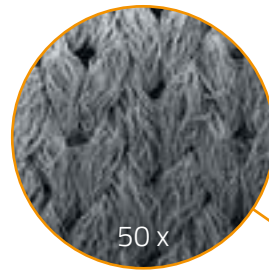

edge
laser cut

100%
Polyester-
Microfiber

155 g/m²

Optionally available in other sizes

K2-109

- Size: 23 x 23 cm | 9 x 9"
- Edges: Laser cut
- Packaging:
150 pcs / bag (pack),
16 packs / carton
[case = 2,400 pcs]

Item no. 2183302

ISO	3	4	5	6	7	8
GMP			A/B		C	D

K2-112

- Size: 30 x 30 cm | 12 x 12"
- Edges: Laser cut
- Packaging:
100 pcs / bag (pack),
10 packs / carton
[case = 1,000 pcs]

Item no. 2183304

K2-109-S [STERILE]

- Size: 23 x 23 cm | 9 x 9"
- Edges: Laser cut
- Packaging:
10 pcs / bag, 10 bags (pack),
10 packs / carton
[case = 1,000 pcs]

Item no. 2183303

ISO	3	4	5	6	7	8
GMP			A/B		C	D

K2-112-S [STERILE]

- Size: 30 x 30 cm | 12 x 12"
- Edges: Laser cut
- Packaging:
10 pcs / bag, 10 bags (pack),
10 packs / carton
[case = 1,000 pcs]

Item no. 2183305

- Optimal for fine cleaning and removal of small particles
- Soft knit structure for sensitive surfaces
- Pre-washed with ultrapure water

PurWipe® K3

Cleanroom Wipe

Polyester-Polyamide-
Microfiber Knit

The high-quality PurWipe® K3 cleanroom wipe has a thick knit material made with finest microfibers which make it perfectly suited for fine cleaning. It does not only offer a high absorption capacity for fluids, but also ensures that sensitive surfaces will not be scratched thanks to its soft texture.

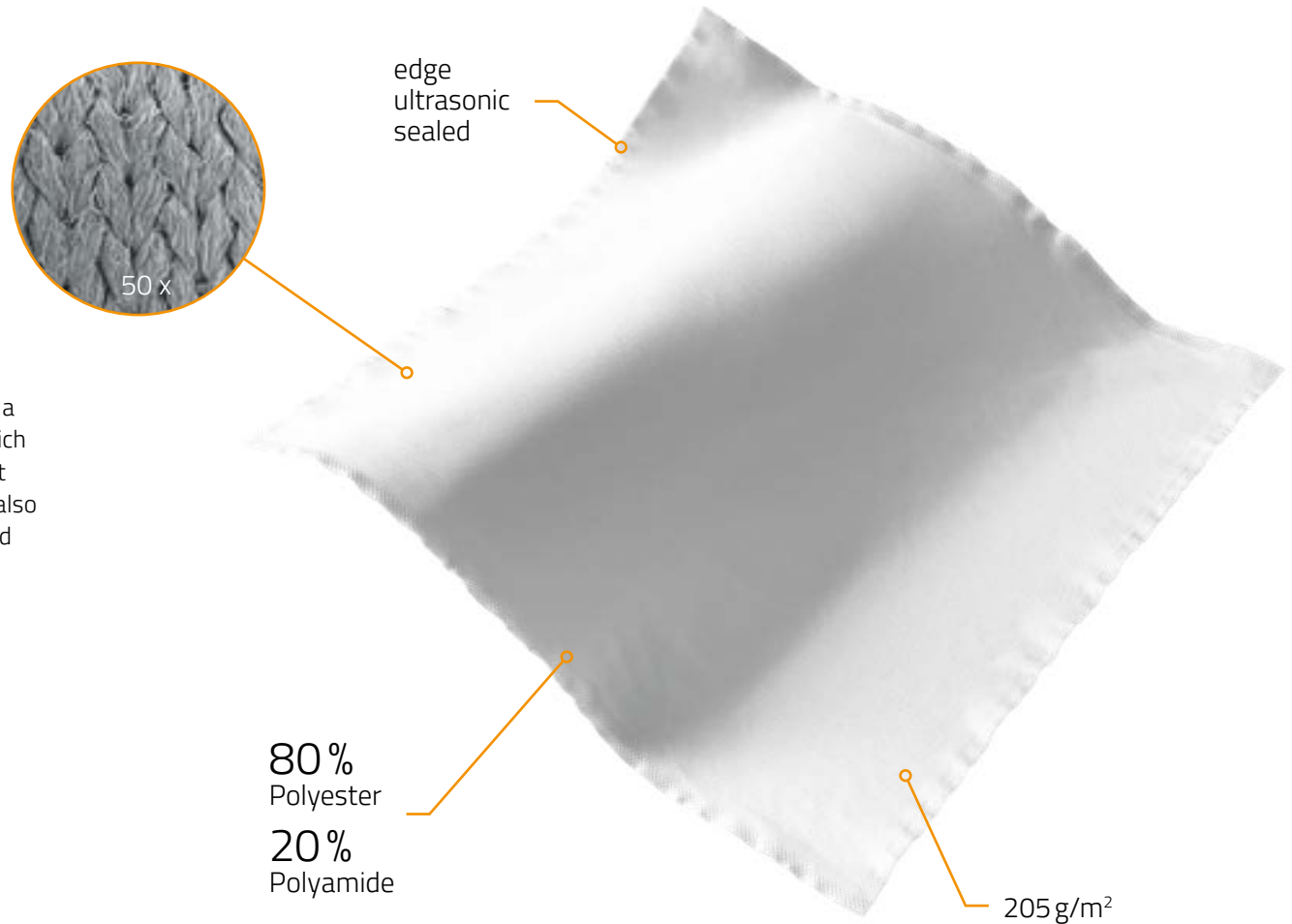

Optionally available in other edges and sizes

K3-309

- Size: 23 x 23 cm | 9 x 9"
- Edges: Ultrasonic sealed
- Packaging:
100 pcs / bag (pack),
20 packs / carton
[case = 2,000 pcs]

Item no. 2183406

ISO	3	4	5	6	7	8
GMP			A/B		C	D

K3-312

- Size: 30 x 30 cm | 12 x 12"
- Edges: Ultrasonic sealed
- Packaging:
100 pcs / bag (pack),
10 packs / carton
[case = 1,000 pcs]

Item no. 2183408

K3-309-S [STERILE]

- Size: 23 x 23 cm | 9 x 9"
- Edges: Ultrasonic sealed
- Packaging:
10 pcs / bag, 10 bags (pack)
10 packs / carton
[case = 1,000 pcs]

Item no. 2183407

ISO	3	4	5	6	7	8
GMP			A/B		C	D

K3-312-S [STERILE]

- Size: 30 x 30 cm | 12 x 12"
- Edges: Ultrasonic sealed
- Packaging:
10 pcs / bag, 10 bags (pack)
10 packs / carton
[case = 1,000 pcs]

Item no. 2183409

- Excellent cleaning ability through microfiber
- Soft texture, ideal for sensitive cleaning tasks
- High absorption capacity for disinfection or chemical spills

PurWipe® K4

Cleanroom Wipe
2-ply Polyester Knit

The PurWipe® K4 is a durable wipe made from an embossed, double-layered polyester knit. The high material weight allows this cleanroom wipe to absorb large amounts of fluid, making it ideal for absorbing spillages and for wiping large surfaces. The knitted material is extremely abrasion resistant and perfectly suited for safe cleaning and disinfection, even on rougher surfaces and stainless steel.

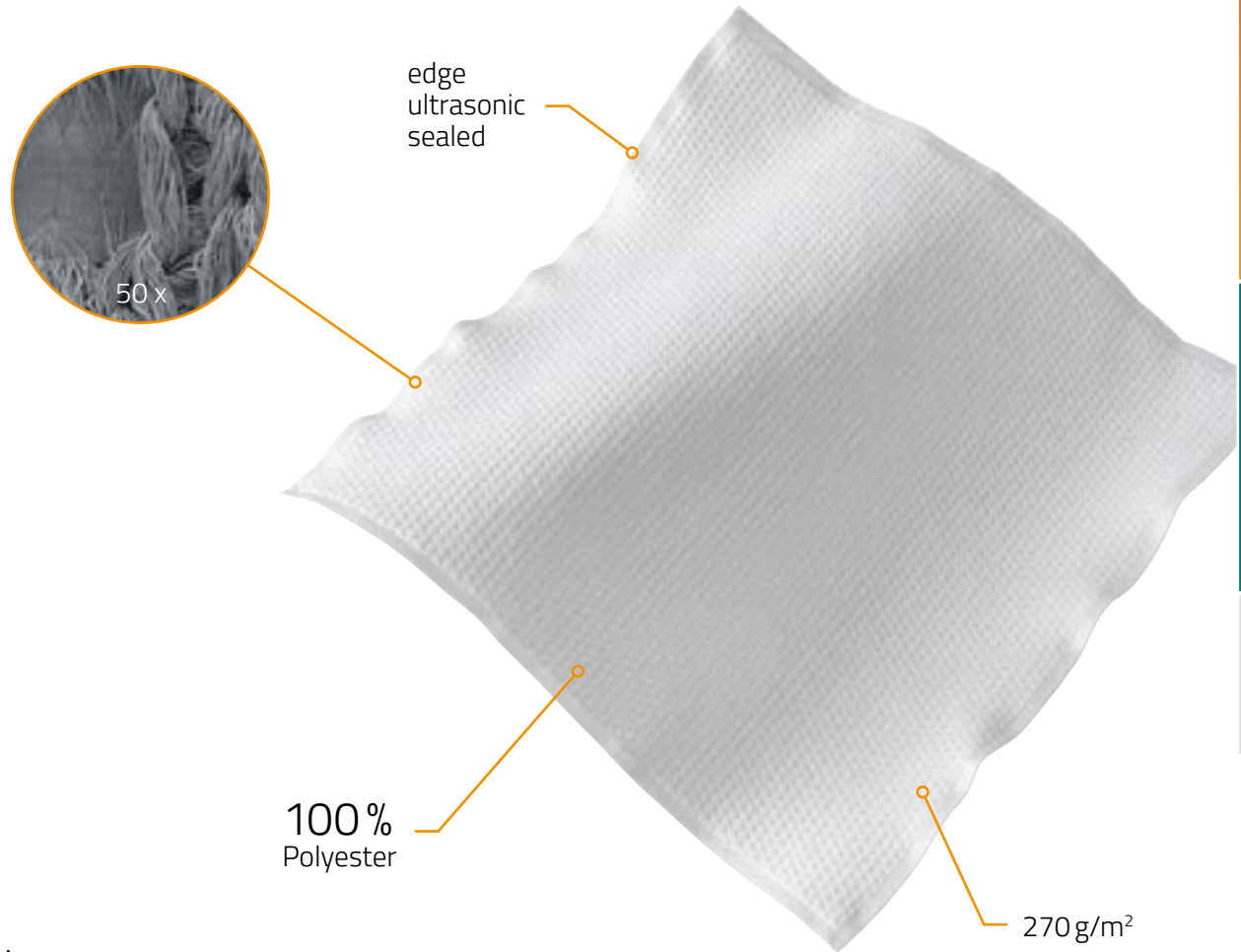

2-PLY
MATERIAL

Optionally available in other edges, sizes and as Basic Line

K4-309

- Size: 23 x 23 cm | 9 x 9"
- Edges: Ultrasonic sealed
- Packaging: 100 pcs / bag (pack), 8 packs / carton [case = 800 pcs]

Item no. 2183600

ISO	3	4	5	6	7	8
GMP			A/B		C	D

K4-312

- Size: 30 x 30 cm | 12 x 12"
- Edges: Ultrasonic sealed
- Packaging: 100 pcs / bag (pack), 8 packs / carton [case = 800 pcs]

Item no. 2183602

K4-309-S [STERILE]

- Size: 23 x 23 cm | 9 x 9"
- Edges: Ultrasonic sealed
- Packaging: 5 pcs / bag, 10 bags (pack), 10 packs / carton [case = 500 pcs]

Item no. 2183601

ISO	3	4	5	6	7	8
GMP			A/B		C	D

K4-312-S [STERILE]

- Size: 30 x 30 cm | 12 x 12"
- Edges: Ultrasonic sealed
- Packaging: 5 pcs / bag, 10 bags (pack), 10 packs / carton [case = 500 pcs]

Item no. 2183603

- Double-layered embossed material
- Excellent fluid absorption
- Optimal for disinfecting stainless steel surfaces



PurWipe®

V-SERIES

Cleanroom Wipes | presaturated

Presaturated Cleanroom Wipes

Ready-to-use, safe and convenient

With our presaturated wipes of the PurWipe® V-Series, we have developed a solution which is ready-to-use from the first wipe. There is no need to use a separate detergent or disinfectant. Safely packed in a resealable pouch, the wipes can be removed individually and used immediately. V-Series wipes eliminate the aerosol concentration caused by spraying of alcohols, the risk of incorrect dosing and time-consuming handling.

Features of our presaturated cleanroom wipes:

- Ready-to-use, presaturated with 70 % IPA / 30 % water
- Available in two different qualities (nonwoven and knitted)
- Processed and packaged in a cleanroom ISO 5
- Effective cleaning and disinfection performance

Product identification

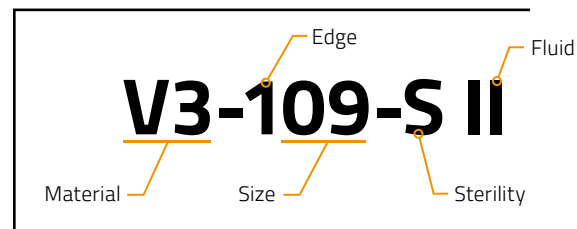

Available edge sealing options

1
Cut



2
Heat sealed



PurWipe® V3

Presaturated Cleanroom Wipe

Polyester-Polyamide-Microfiber Nonwoven

The innovative PurWipe® V3 wipe is characterized by its exceptionally robust material and great cleaning ability. The microfiber nonwoven material consists of 100 % synthetic fibers and is ideally suited not only for general cleaning tasks in cleanrooms, but also for the disinfection of a wide range of surfaces.

- Ready-to-use presaturated, individually removable
- Extremely tear-resistant and robust
- High saturation level for effective surface coverage
- Highest cleaning ability through microfiber

Wipe model:
N2-Series

see page 91

Microfiber Efficiency



30 pcs
per pouch

V3-109

- Presaturated with IPA 70% / DI water 30%
- Size: 23x23 cm | 9x9"
- Edges: Cut
- Packaging: 30 pcs / pouch, 5 pouches (pack), 4 packs / carton [case = 600 pcs]

Item no. 2186100

ISO	3	4	5	6	7	8
GMP			A/B		C	D

V3-112

- Presaturated with IPA 70% / DI water 30%
- Size: 23x23 cm | 9x9"
- Edges: Cut
- Packaging: 30 pcs / pouch, 5 pouches (pack), 4 packs / carton [case = 600 pcs]

Item no. 2186102

V3-109 II

- Presaturated with IPA 70% / WFI quality water 30%
- Size: 23x23 cm | 9x9"
- Edges: Cut
- Packaging: 30 pcs / pouch, 5 pouches (pack), 4 packs / carton [case = 600 pcs]

Item no. 2186200

V3-112 II

- Presaturated with IPA 70% / WFI quality water 30%
- Size: 30x30 cm | 12x12"
- Edges: Cut
- Packaging: 30 pcs / pouch, 5 pouches (pack), 4 packs / carton [case = 600 pcs]

Item no. 2186202

V3-109-S [STERILE]

- Presaturated with IPA 70% / DI water 30%
- Size: 23x23 cm | 9x9"
- Edges: Cut
- Packaging: 30 pcs / pouch, 5 pouches (pack), 4 packs / carton [case = 600 pcs]

Item no. 2186101

ISO	3	4	5	6	7	8
GMP			A/B		C	D

V3-112-S [STERILE]

- Presaturated with IPA 70% / DI water 30%
- Size: 30x30 cm | 12x12"
- Edges: Cut
- Packaging: 30 pcs / pouch, 5 pouches (pack), 4 packs / carton [case = 600 pcs]

Item no. 2186103

V3-109-S II [STERILE]

- Presaturated with IPA 70% / WFI quality water 30%
- Size: 23x23 cm | 9x9"
- Edges: Cut
- Packaging: 30 pcs / pouch, 5 pouches (pack), 4 packs / carton [case = 600 pcs]

Item no. 2186201

V3-112-S II [STERILE]

- Presaturated with IPA 70% / WFI quality water 30%
- Size: 30x30 cm | 12x12"
- Edges: Cut
- Packaging: 30 pcs / pouch, 5 pouches (pack), 4 packs / carton [case = 600 pcs]

Item no. 2186203

PurWipe® V4

Presaturated Cleanroom Wipe

Polyester Knit

The high-quality PurWipe® V4 wipe consists of a durable polyester double knit material. Thanks to its three-dimensional structure it can effectively trap and remove particles from cleanroom surfaces. This premium wipe features heat sealed edges and is pre-washed to a high purity, making it suitable for even the most critical of cleanroom applications and for a wide range of uses.

- High quality 100 % polyester knit wipe
- Ready-to-use presaturated, individually removable
- High saturation level for effective surface coverage
- Heat sealed edges, low particle emission and high purity



V4-209

- Presaturated with IPA 70% / DI water 30%
- Size: 23 x 23 cm | 9 x 9"
- Edges: Heat sealed
- Packaging: 20 pcs / pouch, 5 pouches (pack), 6 packs / carton [case = 600 pcs]

Item no. 2186000

ISO	3	4	5	6	7	8
GMP			A/B		C	D

V4-212

- Presaturated with IPA 70% / DI water 30%
- Size: 30 x 30 cm | 12 x 12"
- Edges: Heat sealed
- Packaging: 20 pcs / pouch, 5 pouches (pack), 6 packs / carton [case = 600 pcs]

Item no. 2186002

V4-209 II

- Presaturated with IPA 70% / WFI quality water 30%
- Size: 23 x 23 cm | 9 x 9"
- Edges: Heat sealed
- Packaging: 20 pcs / pouch, 5 pouches (pack), 6 packs / carton [case = 600 pcs]

Item no. 2186204

V4-212 II

- Presaturated with IPA 70% / WFI quality water 30%
- Size: 30 x 30 cm | 12 x 12"
- Edges: Heat sealed
- Packaging: 20 pcs / pouch, 5 pouches (pack), 6 packs / carton [case = 600 pcs]

Item no. 2186206

V4-209-S [STERILE]

- Presaturated with IPA 70% / DI water 30%
- Size: 23 x 23 cm | 9 x 9"
- Edges: Heat sealed
- Packaging: 20 pcs / pouch, 5 pouches (pack), 6 packs / carton [case = 600 pcs]

Item no. 2186001

ISO	3	4	5	6	7	8
GMP			A/B		C	D

V4-212-S [STERILE]

- Presaturated with IPA 70% / DI water 30%
- Size: 30 x 30 cm | 12 x 12"
- Edges: Heat sealed
- Packaging: 20 pcs / pouch, 5 pouches (pack), 6 packs / carton [case = 600 pcs]

Item no. 2186003

V4-209-S II [STERILE]

- Presaturated with IPA 70% / WFI quality water 30%
- Size: 23 x 23 cm | 9 x 9"
- Edges: Heat sealed
- Packaging: 20 pcs / pouch, 5 pouches (pack), 6 packs / carton [case = 600 pcs]

Item no. 2182005

V4-212-S II [STERILE]

- Presaturated with IPA 70% / WFI quality water 30%
- Size: 30 x 30 cm | 12 x 12"
- Edges: Heat sealed
- Packaging: 20 pcs / pouch, 5 pouches (pack), 6 packs / carton [case = 600 pcs]

Item no. 2182007

PurWipe®

PACKAGING CONCEPT

A detailed packaging concept along with cleanroom suitable packaging materials are standard for all our PurWipe® wipes. The triple packaging allows contamination-free entry into any cleanroom area, while the batch-specific labelling on the inner packaging level provides maximum safety and traceability.

Highlights of the PurWipe® packaging:

- Cleanroom manufactured packaging material
- Clear polybag with easy-tear function (allows safe and particle-free opening)
- Triple packaging as standard for sterile products
- Label with all relevant product details and batch information on each inner bag
- Colour-coding of labels for non-sterile and sterile products
- Gamma-irradiation indicator to check irradiation of sterile products



Sterilization

The bioburden of cleanroom consumables is an important factor in all GMP-regulated cleanrooms. A wipe that is used for cleaning and disinfection of surfaces should not become a source of contamination itself. For GMP cleanroom classes C and above, we recommend the usage of sterile wipes – this is the only way to surely prevent microbial contamination from entering your cleanroom.

Sterile PurWipe® wipes are gamma sterilized and have a sterility assurance level (SAL) of 10^{-6} . The sterilization process is fully validated according to DIN EN ISO 11137 and completely documented. The label includes a sterilization indicator, which allows you to visually check if the sterilization has been successful.

Outer packaging: [carton]

Printed carton
Label with all relevant details (batch number / expiry date / product details)

1 Outer packaging: [carton liner]

PE carton liner

2 Secondary packaging: [pack]

Sealed cleanroom HDPE bag
With easy-tear function for easy opening

3 Primary packaging: [bag]

Sealed cleanroom HDPE bag
With easy-tear function for easy opening
Label with all relevant details (batch number / expiry date / product details)





PurWipe® and SaniWipe®

REUSABLE

Microfiber Wipes

Reusable Microfiber Wipes

High cleaning ability for non-critical applications

The reusable wipes of the PurWipe® and SaniWipe® ranges combine highest cleaning performance with an optimal fluid absorption and best durability. PurWipe® Premio is designed for multiple usage in cleanrooms, while PurWipe® Texturo is suitable for multiple usage in hygienic areas outside cleanrooms. Texturo can be ordered in 4 different colours for effective color coding by area of application.

Features of our reusable microfiber wipes:

- Consists of finest microfiber for highest cleaning performance
- High absorbency for fluids, thanks to a high material volume
- High quality knit, washable and reusable multiple times

Available edges

1
Binding



2
Overlock
sewing



PurWipe® PREMIO

Reusable Cleanroom Wipe

Polyester-Polyamide-Microfiber Knit

The PurWipe® Premio 3030 consists of a high-quality microfiber knit and was specially developed for multiple use in cleanrooms. Its structured side is suitable for all surfaces and allows removal of coarser contamination, while its smooth side with tiny microfibers is suitable for sensitive surfaces and reliable traps even smallest particles.

The PurWipe® Premio 3030 can be washed and autoclaved for 10 cycles and allows tracking of cycles on the attached label.

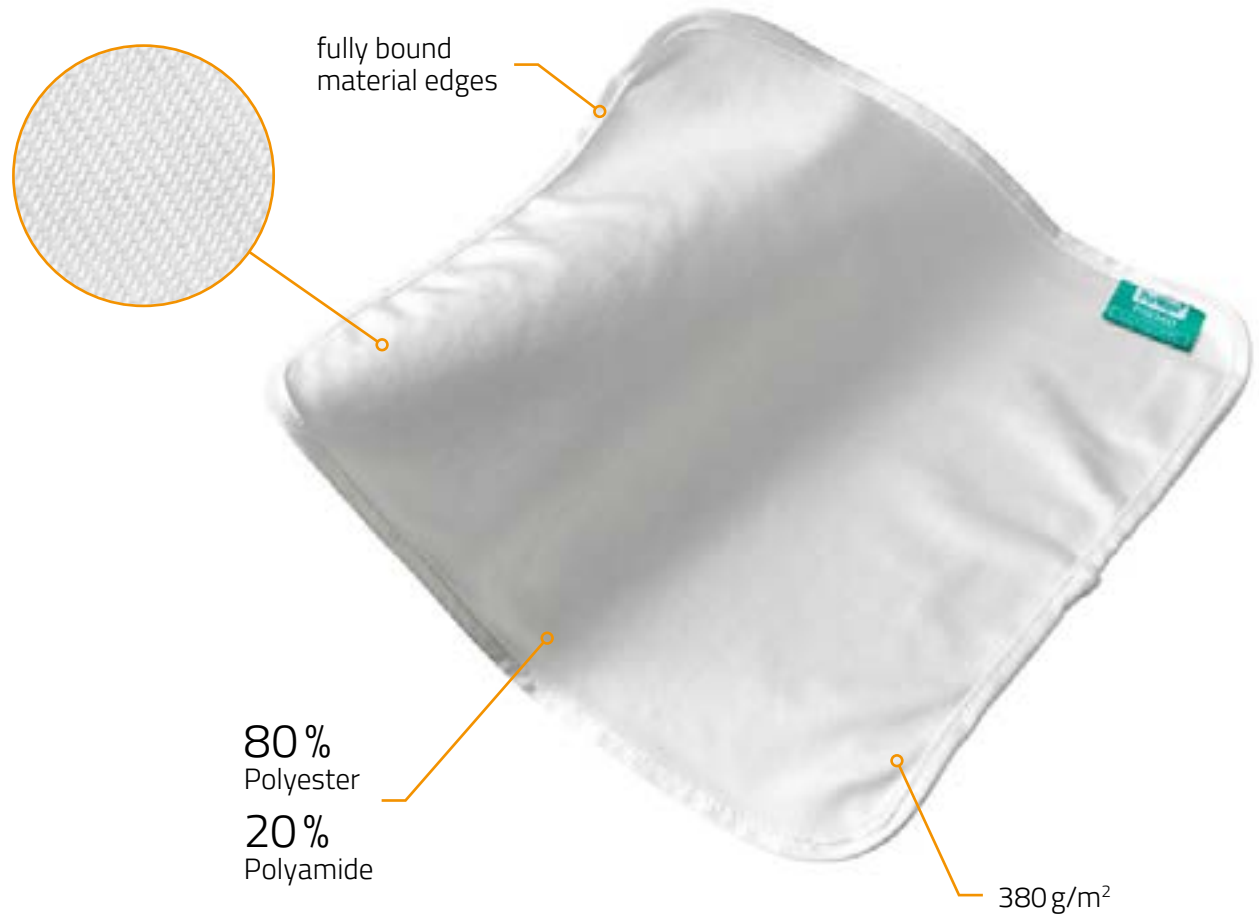

PREMIO 3030

- Size: 32x32 cm | 13x13"
- Packaging:
10 pcs / bag,
5 bags / carton
[case = 50 pcs]

Item no. 2184001

ISO	3	4	5	6	7	8
GMP			A/B		C	D



Label with integrated wash cycle grid for easy tracking.

- Fine Microfiber for highest cleaning ability
- Good absorption capacity, suitable for disinfection
- Fully bound material edges (polyester tape)
- Label with integrated wash cycle grid
- 10 times washable and autoclavable

SaniWipe® TEXTURO

Reusable Hygiene Wipe

Polyester-Polyamide-Microfiber Knit

The SaniWipe® Texturo 3535 is a high-quality and effective microfiber cloth for general cleaning in hygienically sensitive areas. The special structure of the cloth along with the tiny microfibers allow the complete absorption of dirt and residues of all kinds. The cloth is available in 4 colors for color coding and washable for multiple reuse.

- High-performance microfiber cloth made of polyester / polyamide
- High dirt and fluid absorption
- Robust and durable, washable up to 95° C

TEXTURO 3535

- Size: 35x35 cm | 14x 14"
- Packaging:
10 pcs / bag,
10 bags / carton
[case = 100 pcs]

Blue: Item no. 2188001_B

Green: Item no. 2188001_G

Orange: Item no. 2188001_O

Red: Item no. 2188001_R

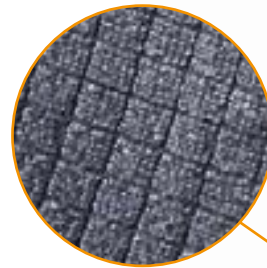

Color coding
via colored
binding tape



Hydroflex



PurGuard™

CLEANROOM GOGGLES

A clear vision for safety

Safety for operators and critical environments

With the PurGuard™ product range we offer protective goggles in both single-use and reusable versions, which have been designed specifically for cleanroom use.

Our goggles provide a high wearer comfort thanks to soft frame material and ventilation holes and a special anti-fog coating prevent fogging of the lenses. Furthermore, our goggles are certified in compliance with international standards, for optimal user safety.

Disposable Goggles

EV-Series 110

Reusable Goggles

SV-Series 112



PurGuard™

GOGGLES

Disposable | Reusable

PurGuard™

EV-100/101

Disposable Goggles

PurGuard™ EV-100 / 101 is a disposable goggle for use in cleanrooms and sterile areas. The ultra soft frame material and adjustable headband offer maximum wearer comfort, even when wearing prescription glasses. The special ventilation design and anti-fog coating effectively prevents fogging.

- Soft and comfortable frame material
- Robust lens material
- Indirect ventilation and anti-fog coating
- Adjustable silicone headband
- CE certified



EV-101
Special clip for
easy length
adjustment



EV-100

anti-fog coating



EV-100 [STERILE]

- Size: One size
- PVC frame, coated PC lens, silicone headband
- EO sterilized, validated according to ISO 11135
- Packaging:
1 pc / pouch, 10 pouches / pack,
5 packs / carton
[case = 50 pcs]

Item no. 2961004

ISO	3	4	5	6	7	8
GMP			A/B		C	D

EV-101 [STERILE]

- Size: One size
- PVC frame, coated PC lens, silicone headband
- Special clip for easy length adjustment
- EO sterilized, validated according to ISO 11135
- Packaging:
1 pc / pouch, 10 pouches / pack,
5 packs / carton
[case = 50 pcs]

Item no. 2961005

ISO	3	4	5	6	7	8
GMP			A/B		C	D

Industries



Disposable goggles advantages

- Eliminates the need for cleaning and sterilization after use
- Goggles are validated sterile and cleanroom suitable at every use
- Easily and quickly adjustable headband

PurGuard™ SV-800

Reusable Goggles

PurGuard™ SV-800 is a reusable and fully autoclavable goggle for use in cleanrooms and sterile areas. The special anti-fog coating and ventilation design prevent fogging. The wide fit and soft frame material offer maximum wearer comfort.

- Soft and comfortable frame material, adjustable silicone headband
- Robust lens material, resistant to disinfectants
- Direct ventilation at the top and indirect ventilation at the bottom
- Suitable for wearing with prescription glasses
- Fully autoclavable
- CE certified



SV-800-AF:
special anti-fog
coating

SV-800

- Size: One size
- PVC frame, PC lens, silicone headband
- Packing:
1 pc / bag, 10 bags / carton
[case = 10 pcs]
(10 cartons / overpack)

Item no. 2962004

ISO	3	4	5	6	7	8
GMP			A/B		C	D

SV-800-AF

- Size: One size
- PVC frame, coated PC lens, silicone headband
- Special anti-fog coating
- Packing:
1 pc / bag, 10 bags / carton
[case = 10 pcs]
(10 cartons / overpack)

Item no. 2962010

ISO	3	4	5	6	7	8
GMP			A/B		C	D

Industries



Good to know

All our reusable PurGuard™ goggles have been tested and are compatible with up to **40** autoclave cycles*.

*for parameters see test report

PurGuard™ SV-900

Reusable Goggles

PurGuard™ SV-900 is a reusable and fully autoclavable goggle used in cleanrooms and sterile areas. The special anti-fog coating and ventilation design prevent fogging. The panoramic lens and soft frame material offer maximum wearer comfort and allround vision.

- Soft and comfortable frame material, adjustable silicone headband
- Robust lens material, resistant to disinfectants
- Direct ventilation at the top and indirect ventilation at the bottom
- Panorama lens
- Fully autoclavable
- CE certified



SV-900-AF:
special anti-fog
coating

SV-900

- Size: One size
- PVC frame, PC lens, silicone headband
- Packing:
1 pc / bag, 10 bags / carton
[case = 10 pcs]
(10 cartons / overpack)

Item no. 2962003

ISO	3	4	5	6	7	8
GMP			A/B		C	D

SV-900-AF

- Size: One size
- PVC frame, coated PC lens, silicone headband
- Special anti-fog coating
- Packing:
1 pc / bag, 10 bags / carton
[case = 10 pcs]
(10 cartons / overpack)

Item no. 2962011

ISO	3	4	5	6	7	8
GMP			A/B		C	D

Industries



Options

Add a ventilation clip to any SV-900 model to turn direct into indirect ventilation (top side only).

VENTILATION CLIP

Item no. 2962101

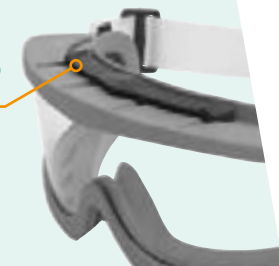



Hydroflex



SERVICE

Perfectly positioned through allround services

Fields of application

Life Sciences Cleanrooms

Regulated by:

GMP (Good Manufacturing Practice)

- Pharmaceutical
- Biotechnology
- Pharmacies
- Medical Device
- Lab & Research

Technical Cleanrooms

Regulated by:

ISO 14644 / VDI 2083

- Microelectronics
- Semiconductor
- Optics & precision mechanics
- Automotive
- Aerospace

Cleanroom Class Indicator

Based on comprehensive tests by Hydroflex and independent testing institutes, we provide a general recommendation for the classification of our products into different cleanroom classes (orange marking). These recommendations are non-binding and due to the various industries of use. They do not replace an individual consultation by Hydroflex or a product qualification, testing and validation by the customer for his specific usage.

ISO	3	4	5	6	7	8
GMP			A/B		C	D

Cleanroom Class Comparison

Cleanrooms are classified into 9 different cleanliness classes by the international industry standard ISO 14644. To compare cleanroom classes of ISO, VDI, Fed.Stand. and GMP, you can use our simple comparison chart.

ISO / VDI	3	4	5	6	7	8	9
Fed. Stand.	1	10	100	1.000	10.000	100.000	
GMP			A/B		C	D	

Samples & Consultation

Expert advice for complex subjects

At Hydroflex, consultation is an integral part of our service to you. With decades of experience in cleanroom technology, our team of experts is happy to support you in identifying the best possible solution for maintaining a clean and safe production environment. Starting with an on-site visit and understanding your challenges and requirements, to providing a full hygiene concept for your cleanrooms and supporting you with know-how and documents in the validation process, we are at your side the whole way.

Product trials

The best way to understand the benefits which Hydroflex cleaning systems can offer, is by testing them yourself. Whether for demonstration purposes, initial user feedback, performance testing or validation trials, we will be pleased to provide you with free of charge samples or demo units for an evaluation period. You can test them under practical conditions or carry out a validation.

REQUEST SAMPLES
info@hydroflex-group.com



Practical demonstration in a mobile cleanroom during a training

We train for safe operation in the cleanroom

The training of all staff working in cleanroom environments is not only a GMP requirement but also an important tool for assuring safety and quality. Humans are the number one source of cleanroom contamination, and so, not only their behaviour and garment concept is important, but also the correct procedure for cleaning and disinfection of surfaces.

Learn about effective cleanroom contamination control

As a specialized manufacturer of cleanroom hygiene solutions, we offer trainings on effective cleanroom cleaning procedures and how they can help to improve the overall production safety and drive compliance with external regulation. We offer our customers specific training programs suited to your individual requirements and performed at your facility, with a focus on practical exercises and participant motivation.

Cleanroom Training - In-House, individual, practical

- Basic training on cleanroom technology, GMP, personal hygiene, behaviour and cleaning
- High rate of practical simulations and trainings
- Performed by certified or experienced professionals
- Our aim: Maximum knowledge transfer, certified qualification, high participant motivation for lasting results

For further information on our trainings, please contact us.

Subject Index

A

Autoclavable mops	32
Autoclavable trolleys	64
Autoclavable handles	47
Autoclavable wipes	106
Autoclavable goggles	112
Aluminium handles	48

B

Bucket systems	76
Buckets (spare parts)	see website
Bucket liners	71
Brushes & brooms	on request
Biocides	on request
BPR registered wipes	100

C

Cleaning trolleys / carts	58
Cleanroom goggles	108
Cleanroom mops	12
Cleanroom training	117
Cleanroom vacuum cleaners	on request
Cleanroom wipes	86

D

Disinfectants & Detergents	on request
Disposable mops	14
Double bucket systems	80
Duo trolley systems	80

E

Ergo trolley systems	60
----------------------	----

F

Flat mop frames	46
Floor mops	16
Frames for mops	46

G

Goggles	108
---------	-----

H

Handles for mops	47
Hygiene mops	40
Hygiene wipes	107

I

Isolator cleaning tool	54
Isolator cleaning mop pads	24

K

Knitted wipes	92
---------------	----

L

Laundered mops	on request
Lockable frames	46
Low linting wipes	91
Low residue wipes	94

M

Microfiber mops	17
Microfiber wipes	91
Mop frames	46
Mop handles	47
Mop wringers	76
Mop waste bags	71
Mop wetting systems	60

Mopping guide	84
Mops	12

N

Nonwoven wipes	88
----------------	----

P

Plastic handles	53
Plastic trolley systems	66
Polyester wipes	94
Presaturation systems	72
Prepare trolley system	72
Presaturated mops	20
Presaturated wipes	98
PurGuard	110
PurMop®	10
PurVac®	on request
PurWipe®	86

R

Recycling system for mops	on request
Reusable mops	32
Reusable wipes	104
Ready-2-use mops	20
Ready-2-use wipes	98
Round mops	39
Round mop frames	46

S

SaniMop®	40
SaniWipe®	107
Single bucket systems	78
Speciality cleaning tools	on request
Stainless steel buckets	see website
Stainless steel frames	46

Stainless steel handles	47
Stainless steel trolleys	64
Sterile mops	16
Sterile wipes	90
Sticky mats	on request
Swabs	on request

T

T-frame for mops	46
Telescopic handles	47
Training courses	117
Triple bucket systems	81
Trolley systems	58
Touchless mopping system	60

V

Vacuum cleaners	on request
-----------------	------------

W

Wall cleaning system	39
Waste bags for mops	71
Wetted wipes	98
Wipes	86
Workbench cleaning tool	54
Wringer systems	76

Although all detail is meticulously researched, the data is subject to change and amendments to technical data, form and functionality are reserved. Illustrations are similar and sometimes arranged to suit the printig format. Any type of reproduction and distribution is subject to written consent by Hydroflex. Hydroflex owns the copyright to all materials.

Article Index

Cleanroom Mops

Item no.	Article	Page
2111005	P40	34
2111006	Z40	35
2111007	R32	39
2111008	R42	39
2111104	EC40	16
2111105	EC40-S	16
2111108	EF40	17
2111109	EF40-S	17
2111111	EC20-S	26
2111115	EC40 PLUS	16
2111116	EC40-S PLUS	16
2111117	EFB40	18
2111118	EFB40-S	18
2111129	EF40-SV	22
2111130	EF40-SV-2P	22
2111132	EC20-SV	28
2111134	EFB40-SV	23
2111138	EX40	19
2111147	EFB40-SV II	23
2111148	EC20-SV II	28
2111149	EF40-SV II	22
2111150	EF40-SV-2P II	22
2111155	EF20-S	27
2112008	ML40	36
2112009	MLB40	37
2112020	MX40	38
2113001	B-7	41

Frames & Handles

Item no.	Article	Page
2131003	SEP140	47
2131005	SET2100	47
2131006	SET2070	47
2131007	SAK170	53
2131009	SA180	53

Item no.	Article	Page
2131011	SAV150	53
2131012	SA400	53
2131013	SEP50	57
2131015	ICT2050	56
2131017	SET2040	57
2131024	ICT2080	56
2131026	SAT2100	49
2131027	SAT2150	49
2131028	ICTA2080	56
2131029	SAT2040	57
2131038	SAT2100-K	49
2131039	SAT2150-K	49
2135032	Adapter	47
2151003	KEU40	46
2151005	KKV40	52
2151006	MEP20	57
2151008	KEK40	46
2151010	KSS40	46
2161001	TE30	46
2161002	TE40	46

Cleaning Trolley

Item no.	Article	Page
2121100	UNO 100	78
2121103	UNO 111	79
2121200	UNO 200	79
2121203	UNO 211	79
2122100	DUO 200	80
2122103	DUO 211	81
2122109	DUO 300	81
2122110	DUO 311	81
2123015	2.0 ERGO 210	66
2123016	2.0 ERGO 230	67
2123017	2.0 ERGO 300	67
2123019	2.0 ERGO 320	67
2123021	2.0 ERGO-S 210	64
2123022	2.0 ERGO-S 230	65
2123023	2.0 ERGO-S 300	65
2123025	2.0 ERGO-S 320	65
2123027	2.0 ERGO 200	66

Item no.	Article	Page
2123028	2.0 ERGO-S 200	64
2123029	2.0 ERGO 205-F	66
2123030	2.0 ERGO-S 205-F	64
2124001	PREPARE	75
2125105	2.0 TRIO 310	83
2125107	2.0 TRIO 330	83
2125109	2.0 TRIO-S 210	82
2125110	2.0 TRIO-S 230	82
2125111	2.0 TRIO-S 240	82
2125116	2.0 TRIO-S 340	83
2126002	PREPARE 311	75
2126100	GO 200	71
2126101	GO 200-F	71
2126102	GO-S 200	70
2126103	GO-S 200-F	70
2130002	MB18-R	71
2130001	MB18-RS	71

Cleanroom Wipes

Item no.	Article	Page
2182005	V4-209-S II	101
2182007	V4-212-S II	101
2183100	N1-109	90
2183101	N1-109-S	90
2183102	N1-112	90
2183103	N1-112-S	90
2183202	K1-209	94
2183203	K1-209-S	94
2183204	K1-212	94
2183205	K1-212-S	94
2183302	K2-109	95
2183303	K2-109-S	95
2183304	K2-112	95
2183305	K2-112-S	95
2183406	K3-309	96
2183407	K3-309-S	96
2183408	K3-312	96
2183409	K3-312-S	96
2183500	N2-109	91
2183501	N2-109-S	91

Item no.	Article	Page
2183502	N2-112	91
2183503	N2-112-S	91
2183600	K4-309	97
2183601	K4-309-S	97
2183602	K4-312	97
2183603	K4-312-S	97
2184001	PREMIO 3030	106
2186000	V4-209	101
2186001	V4-209-S	101
2186002	V4-212	101
2186003	V4-212-S	101
2186100	V3-109	100
2186101	V3-109-S	100
2186102	V3-112	100
2186103	V3-112-S	100
2186200	V3-109 II	100
2186201	V3-109-S II	100
2186202	V3-112 II	100
2186203	V3-112-S II	100
2186204	V4-209 II	101
2186206	V4-212 II	101
2188001_B	TEXTURO 3535 Blue	107
2188001_G	TEXTURO 3535 Green	107
2188001_O	TEXTURO 3535 Orange	107
2188001_R	TEXTURO 3535 Red	107

Cleanroom Goggles

Item no.	Article	Page
2961004	EV-100	111
2961005	EV-101	111
2962003	SV-900	113
2962004	SV-800	112
2962010	SV-800-AF	112
2962011	SV-900-AF	113
2962101	VENTILATION CLIP	113

hydroflex-group.com

Distributed by:

HEADQUARTERS

Hydroflex Group GmbH
Am Weidenhäuser Bahnhof 8
35075 Gladenbach
Germany

T +49 6462 91598-0
F +49 6462 91598-20
info@hydroflex-group.com

AMERICA

Hydroflex USA, Inc.
Houston · TX 77060
United States

T +1 832-295-9495
usa@hydroflex-group.com

ASIA

Hydroflex Asia Co., Ltd.
61, Munhyeon-ro, Opo-eup
Gwangju-si, Gyeonggi-do
12774 Korea

T +82 31 764 6462
F +82 31 797 0387
asia@hydroflex-group.com